



REISS AUDIO

your car hifi specialist

AMPLIFIER OWNER'S MANUAL



Models:

RS-Q2500.1D/RS-Q700.4D1/RS-Q700.4D4/RS-Q150.8D

THANK YOU

Thank you for choosing **REISS AUDIO/RS-Q** amps! Your choice of **REISS AUDIO/RS-Q** amps indicates a desire for high quality music reproduction in the automobile. **REISS AUDIO/RS-Q** amps brings to you over four decades of car audio expertise. So whether you are a daily driving music lover, or a serious car audio competitor, **REISS AUDIO/RS-Q** amps have the product for you!

To take full advantage of the **REISS AUDIO/RS-Q** amps gear you have just purchased, please read and follow the instructions in this manual. As with all of our products, professional installation by an authorized **REISS AUDIO** dealer is highly recommended! Otherwise, the performance of your new gear may not be satisfactory. In addition to the installation services and expertise offered by an authorized **REISS AUDIO** dealer, the warranty of this product may be extended when installed by an authorized **REISS AUDIO** dealer. Be sure to ask your authorized **REISS AUDIO** dealer about whether your product may qualify for an extended warranty. You're Headed in the Right Direction with **REISS AUDIO/RS-Q** amps!

INTRODUCTION

The **REISS AUDIO/RS-Q** amplifiers offer high quality audio reproduction for the audiophile and the everyday listener alike. All models feature fully variable crossovers with 12 dB per octave slopes, allowing you the ability to tailor the sound to best fit the speakers and your listening preferences.

Platinum finish connections Ensures solid electrical connections that resist corrosion.

Fully Variable Crossovers Fully variable crossovers promote installation ease and save the cost of outboard crossovers. Additionally, they may be used in conjunction with outboard passive or active crossovers, depending on the complexity required by the system. The 12 dB per octave slope offers steep roll-off above or below the selected frequency.

Protection Circuitry Against Overload, Short Circuit, Thermal, Low Voltage, High Voltage, and Reverse Polarity. These Protection features are designed to protect the amplifier from misuse, as well as from common causes of amplifier failure.

INSTALLATION

Professional installation by an authorized **REISS AUDIO** dealer is highly recommended! Otherwise, the performance of your new gear may not be satisfactory. In the event that you decide to do your own installation, please read and follow this manual very carefully. Failure to do so may compromise the integrity of this product, your automobile, and possibly void the product warranty.

Amplifiers are generally mounted in the hatch/trunk area of a car or SUV, and under or behind the seat of most pick up trucks. Select a location that will provide adequate ventilation for the amplifier. Avoid mounting the amplifier with the fins facing down. The fins should be facing up, either vertically or horizontally. Secure the amplifier with the screws provided.

INPUT CONFIGURATION

Before securing the amplifier, inspect the mounting location carefully to ensure that you do not drill into or damage any electrical, hydraulic, fluid, or fuel lines.

Input Section

Because of the wide range of head unit output configurations all **REISS AUDIO/RS-Q** amps have an adjustable input sensitivity of gain, the gain is not a volume or a power limiting control like a throttle. It makes the amp more sensitive to input from the stereo. With the gain up the amp will reach full output at a lower volume setting on the deck. At higher gain settings the amp also becomes more sensitive to noise from the car's electrical system. Try to run the gain at the lowest setting possible for your system.

There is no correct gain setting. Because speakers require different power demands to reach the same output, the gains most often need to be used to compensate for these differences. If you tried to set all the gains at half way you would probably find the system didn't sound very good. Using good judgment and listening carefully to each speaker is still the best way to tune a system.

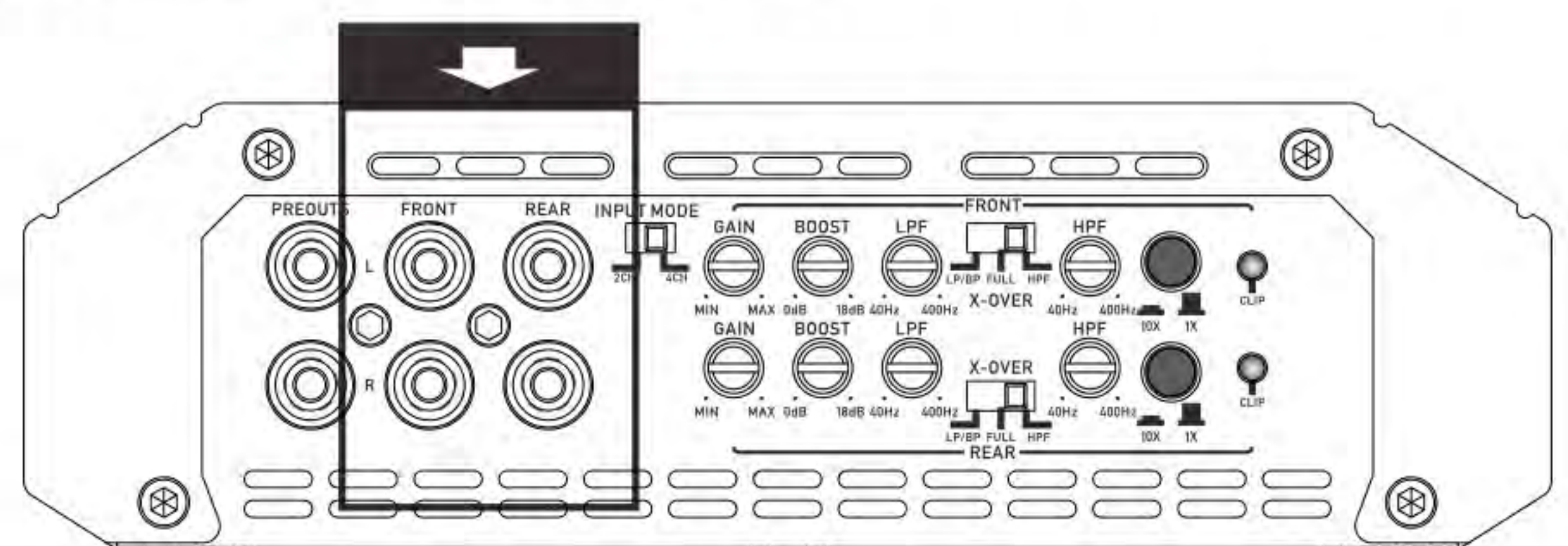

CROSSOVER CONTROLS

A crossover is a device that removes unwanted frequencies from a speaker or amplifier. A tweeter can easily be destroyed by bass notes if they are not filtered out. Likewise a subwoofer will not sound natural if it is playing midrange notes. A crossover removes these sounds from the speaker. As you might guess, careful adjustment in need to ensure that all the speakers are playing the right sounds and that you are left with no “holes” or low

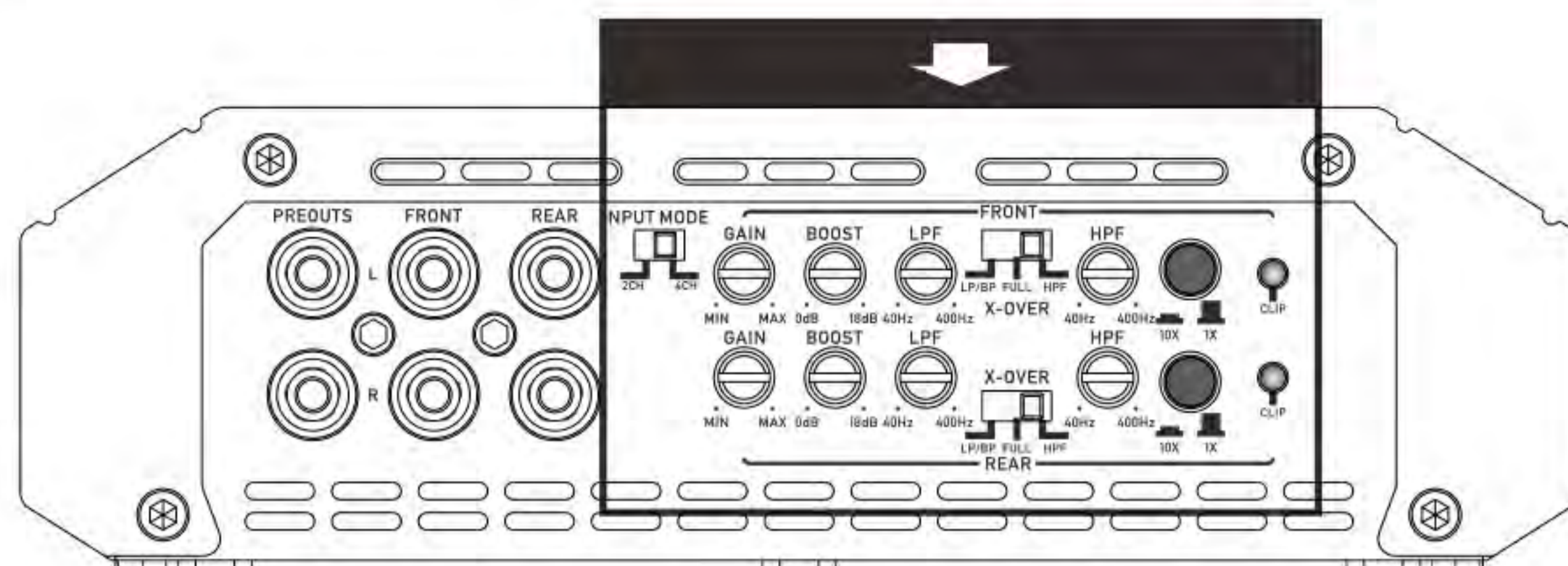

SPEAKER OUTPUTS

This amplifier is a multi channel amplifier design. Meaning it has more than one channel of speaker outputs. It is equipped with a large block style terminal for speaker connection. Make this connection carefully and neatly. Strip your wire back and twist the exposed leads and insert them into the block terminal while being careful that there is no loose or frayed strands of wire and tighten the Allen head screw down on the terminal till the wire is tightly secured in place.

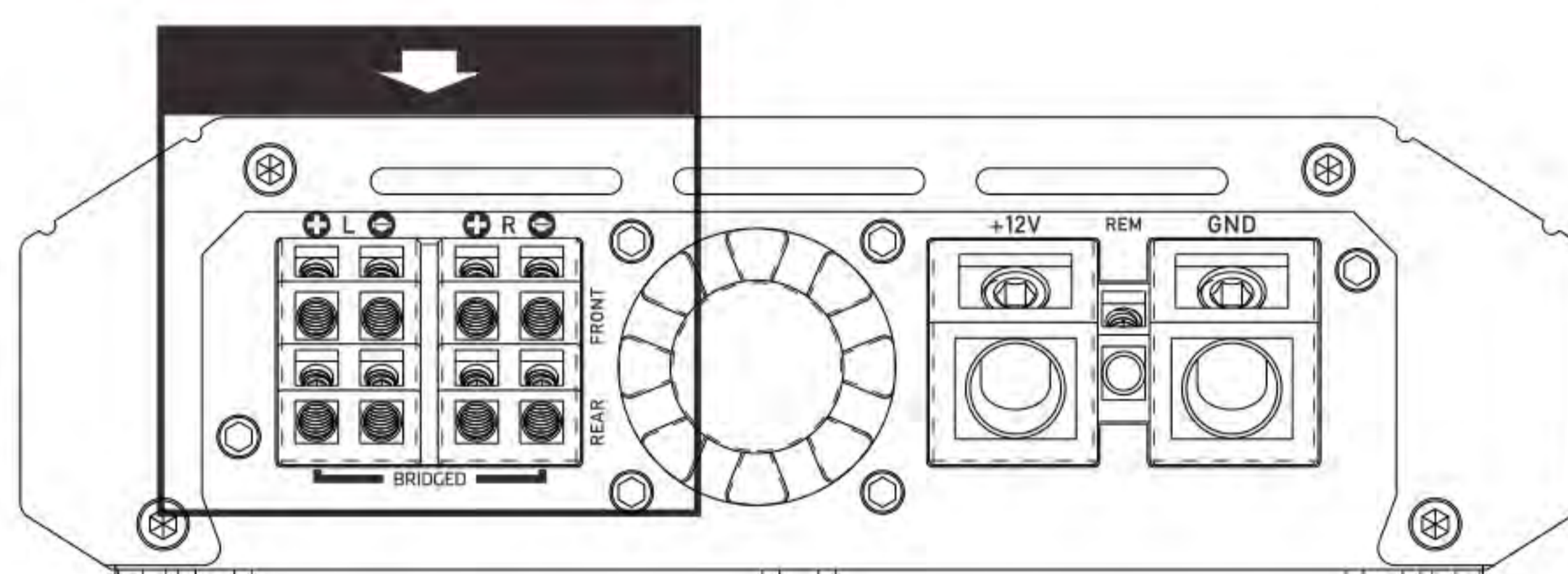

If the wires ever come in contact with each other the amplifier will go into protection. **Know your total ohm load before you make any connections.**

BASS BOOST AND CONT

REISS AUDIO /RS-Q2500.1D amplifiers have an adjustable bass boost which controlled by a potentiometer selecting the most commonly used BASS BOOST setting. Begin your adjustments at low volume. If you do not hear any improvement then woofer does not need any BASS BOOST. The Low Pass Filter(LPF) must be switched on for the bass boost to activate.

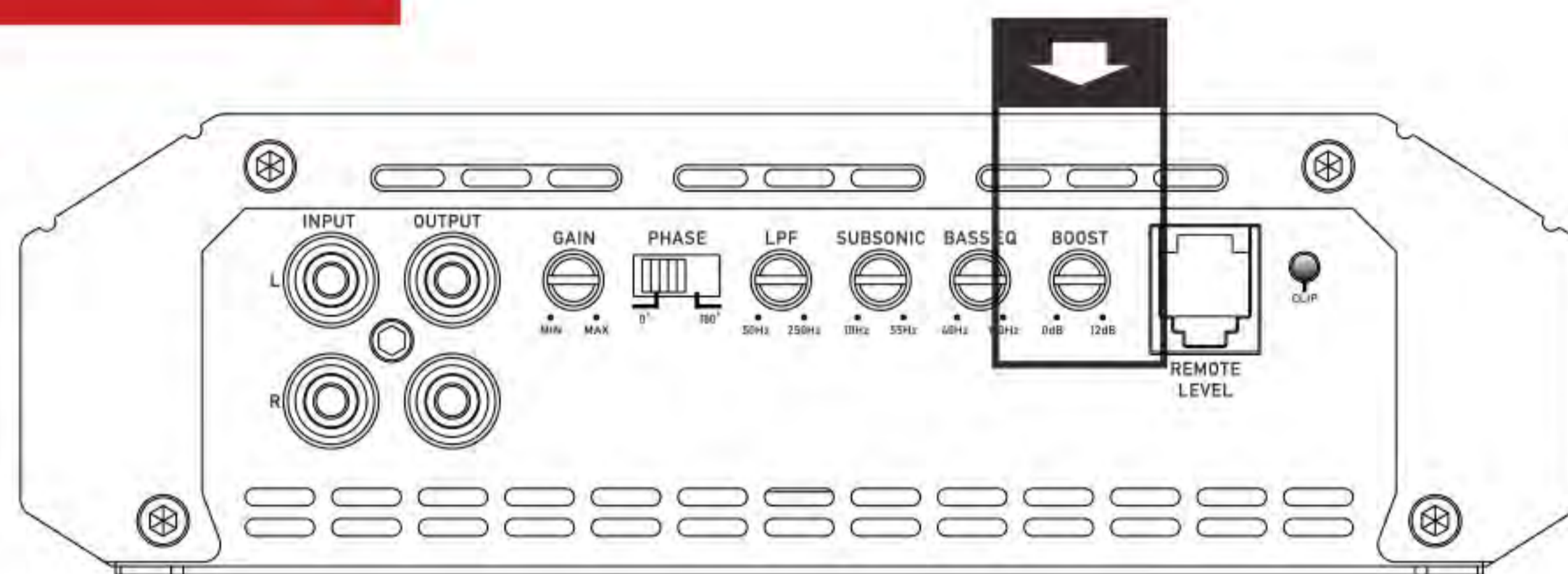

Begin your adjustments at low volume. Turn the Bass Boost Level control about 1/2 way up. Next, turn the Bass Boost Frequency up and down. this will take some tweaking but try to find the setting that gives you a richer and fuller sound without over working the subwoofer . Play several different kinds of music to test your adjustment You may find you have to go back and make some changes and compromises to get it sounding right with an assortment of music. Use Bass Boost carefully. The demands on power output are tremendous. Try to minimize the use by changing woofer position or the enclosure size.

INSTALLATION INSTRUCTIONS

1. Before you start, disconnect the negative cable from the car battery. Tape up the end so it is isolated from the battery.
2. Run an appropriate gauge wire from the battery to the amplifier. Plan this part of the installation carefully. this cable will carry very high current. If it should short to the body and it is not properly fused it could catch fire.
3. Connect the power wire to the battery using a fuse capable of the total current load of all amplifiers connected. **Don't install the fuse yet.** Wait until the end. locate the fuse as close as possible to the battery. If the fuse is further that 18 inches(wire length)from the battery you should reevaluate the wire and fuse placement.

4. Find the closest clear metal area to the amp for a ground. sand, grind or scrape all paint and undercoating from the body and screw the ground securely in place.
It is advisable to test the ground with an ohmmeter between the ground cable and the negative battery cable to insure a good low resistance connection. Some alloys used in modern cars do not offer the best ground..If you believe this is the case consult with the vehicle manufacturer.
5. Run the speaker wire to the speakers.It is advised that you leave some extra wire at this point. You can “clean it up” later.
6. If you haven't already done so, mount the amp now.
7. Connect the power and ground to the amplifier.
Only after this step should you install the fuse at the battery.
8. Connect the remote wire from the head unit to the amplifier .Now is a good time to turn on the amp for the first time. Make sure it turns on properly and does not go into protection.
9. Connect the speaker wires to the amp and speakers (make sure the amp is off first).Make sure the polarity(+add-)is correct.
10. Connect the RCA'S to the amp.
11. Double check the amplifier controls at this time. Make sure everything is set correctly for your system.
12. Now you're ready to play it for the first time. It is best to leave the gain all the way down at first. Start with the head unit volume low and work your way up.
13. Now you can tune the amp. Take your time and make only one adjustment at a time. It may take some time to get the system fully adjusted. During this time the amp is drawing current from the battery. You should check the battery voltage from time to time and re-charge it if it gets low. that's it. You're done. Now have fun.

FEATURES

- Balanced Differential Inputs for Noise-Free Operation Regardless of the source
- Heavy & Thick Aluminum Heatsink Provides Fast Heat Dissipation
- High Performance Class-D Topology
- Compact Size footprint for easy installation of Many Applications
- Variable Full Crossover Filter: LPF / FULL / HPF (LPF / SUBSONIC for RS-Q2500.1D)
- High Level JRC4580 OPAMP pre-amp Circuit and Multi-Filterings to Ensure High Sound Quality
- Surface Mount Component Technology
- Audio Precision Quality Control Verification
- Stable & Reliable Four Layers PCB Trace Layout
- Power & Protection & Clipping Led Lights Status Indicator
- 12dB Per Octave Slopes for Multi-Channels Models & 24dB Per Octave Slope for Mono Models
- Short circuit, thermal, DC offset, Overload and Voltage protections
- Bass Knob Controller for RS-Q2500.1D
- Working Status Leds Illuminated Under Brand Logo

NORMAL INSTALLATION (RS-Q2500.1D)

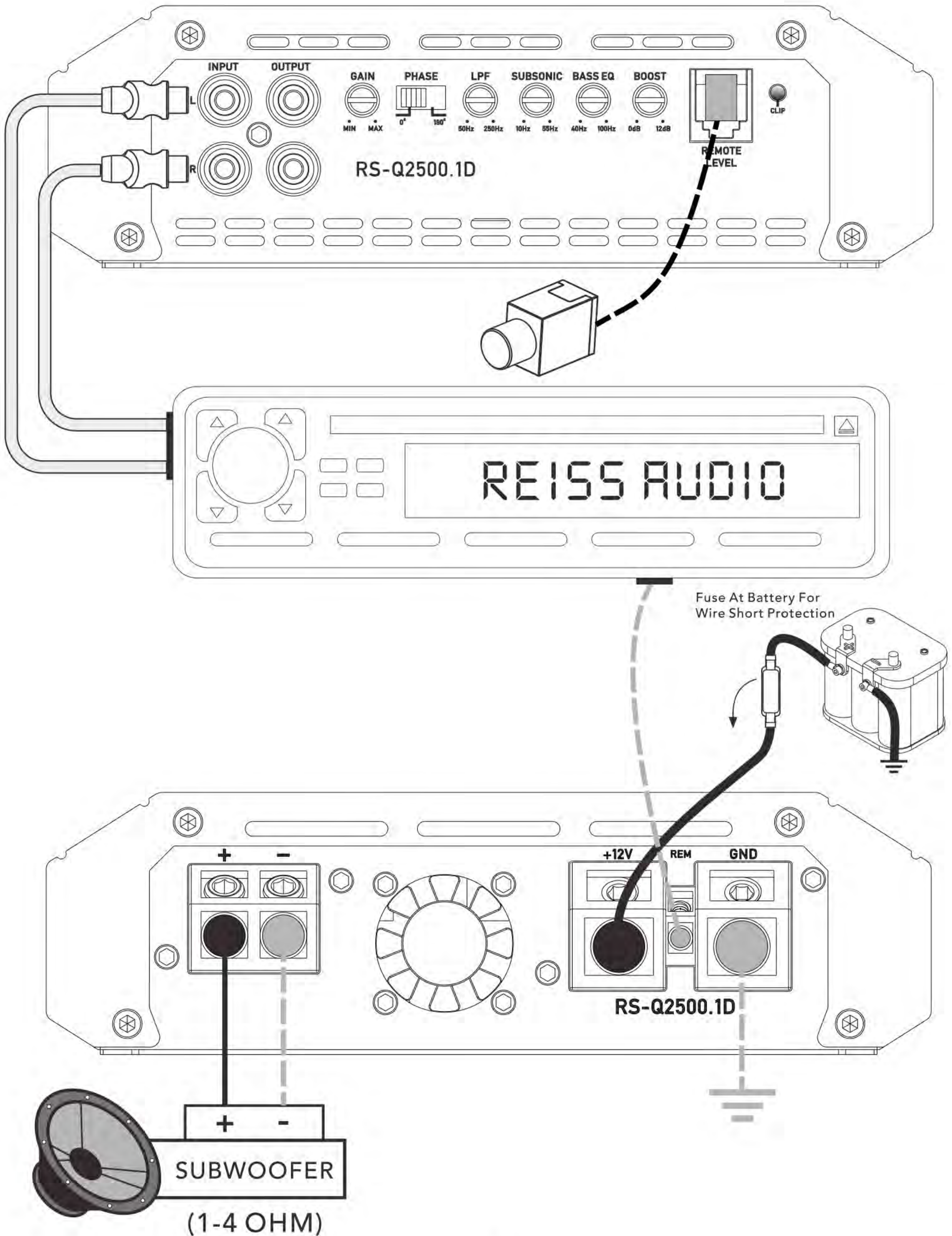

NORMAL INSTALLATION (RS-Q700.4D1/RS-Q700.4D4)

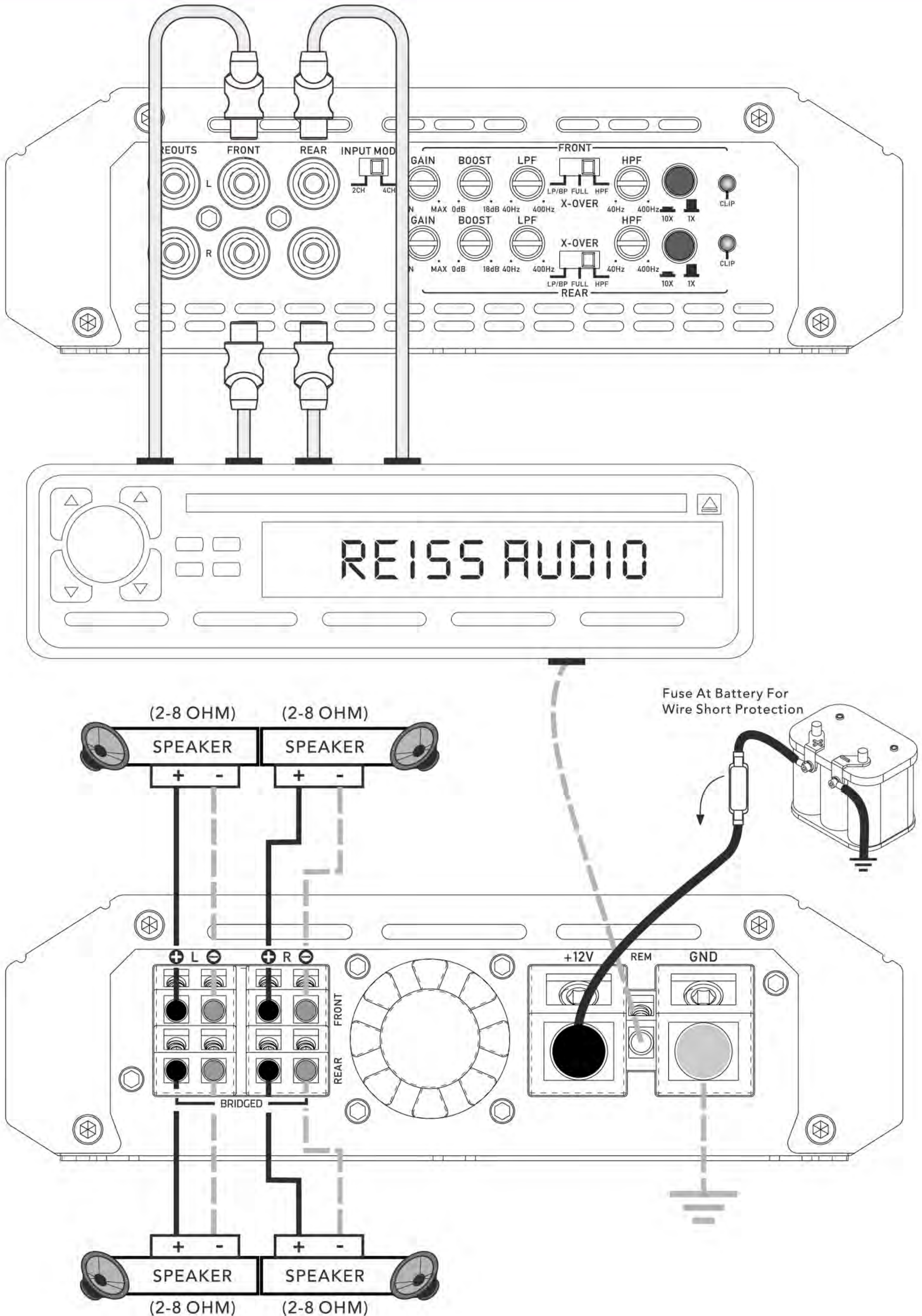

Fuse At Battery For Wire Short Protection

BRIDGE INSTALLATION (RS-Q700.4D1/RS-Q700.4D4)

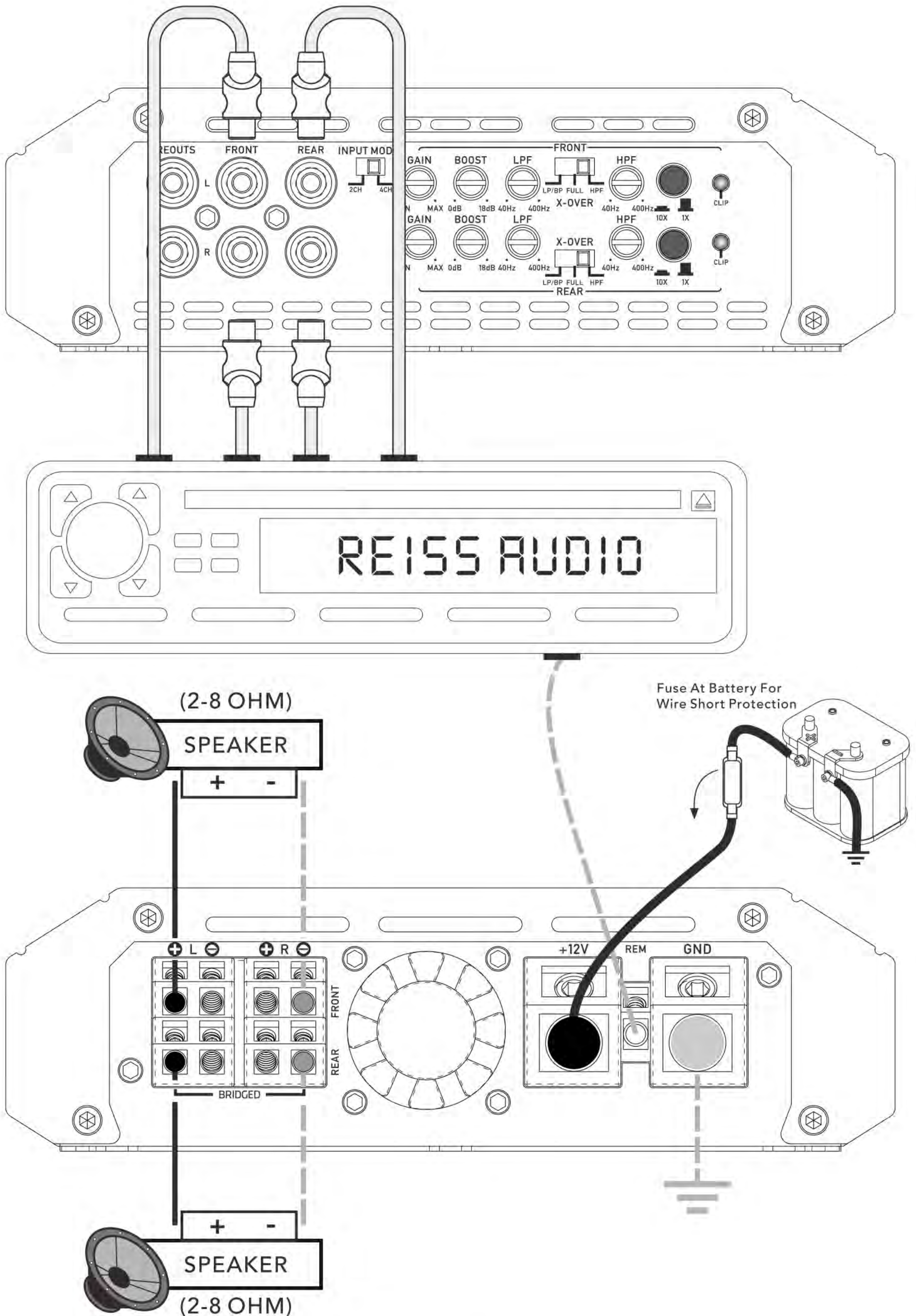

NORMAL INSTALLATION (RS-Q150.8)

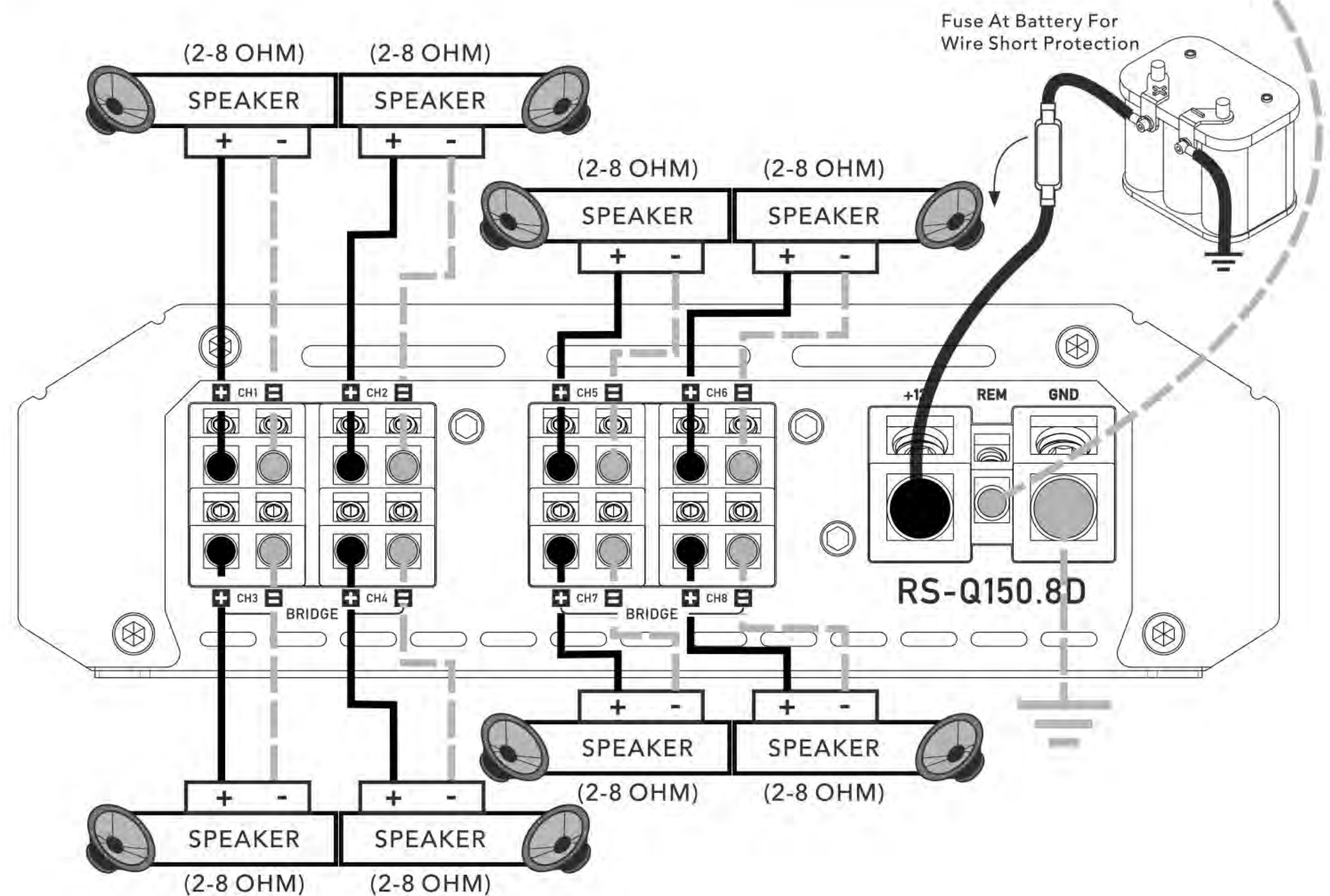
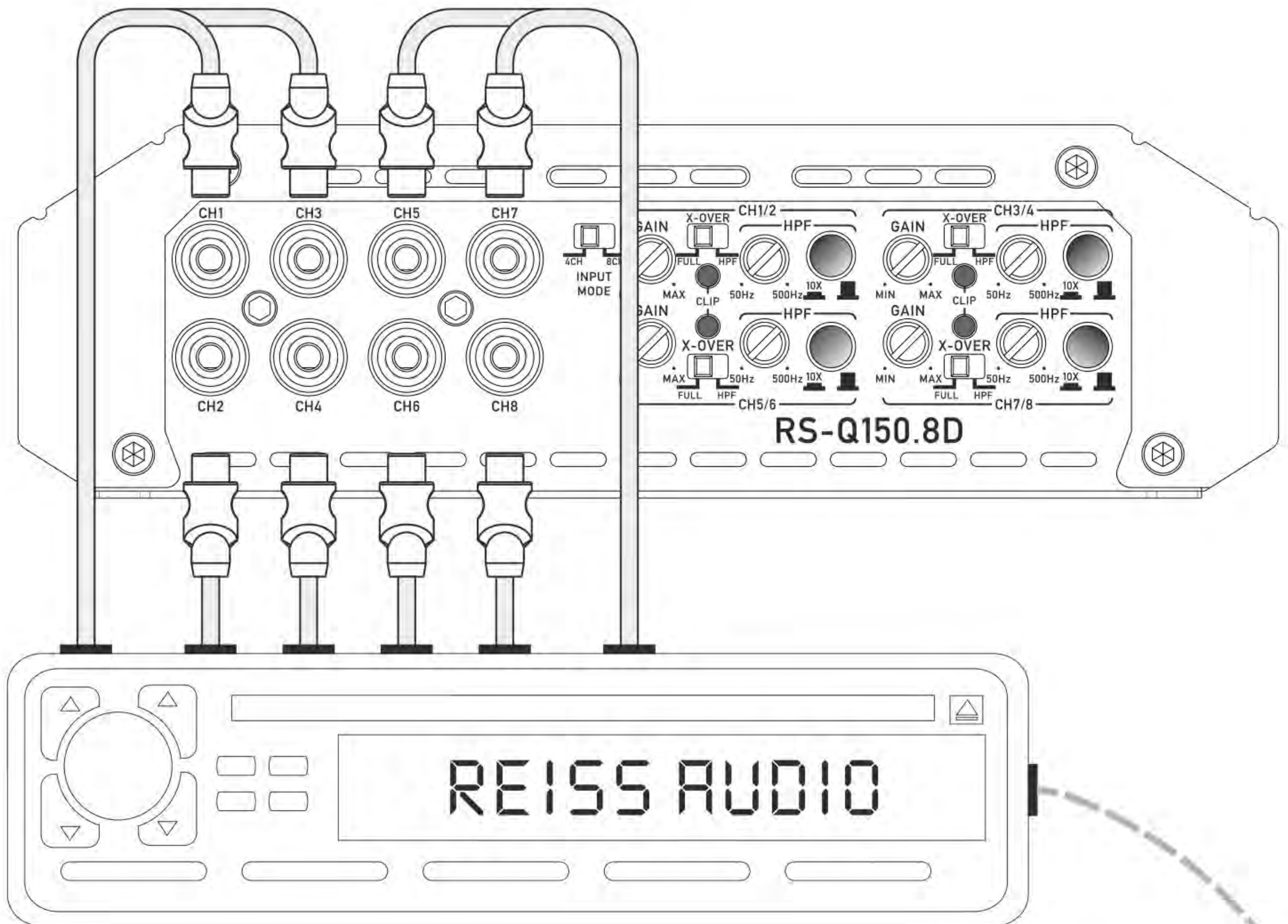

BRIDGE INSTALLATION (RS-Q150.8)

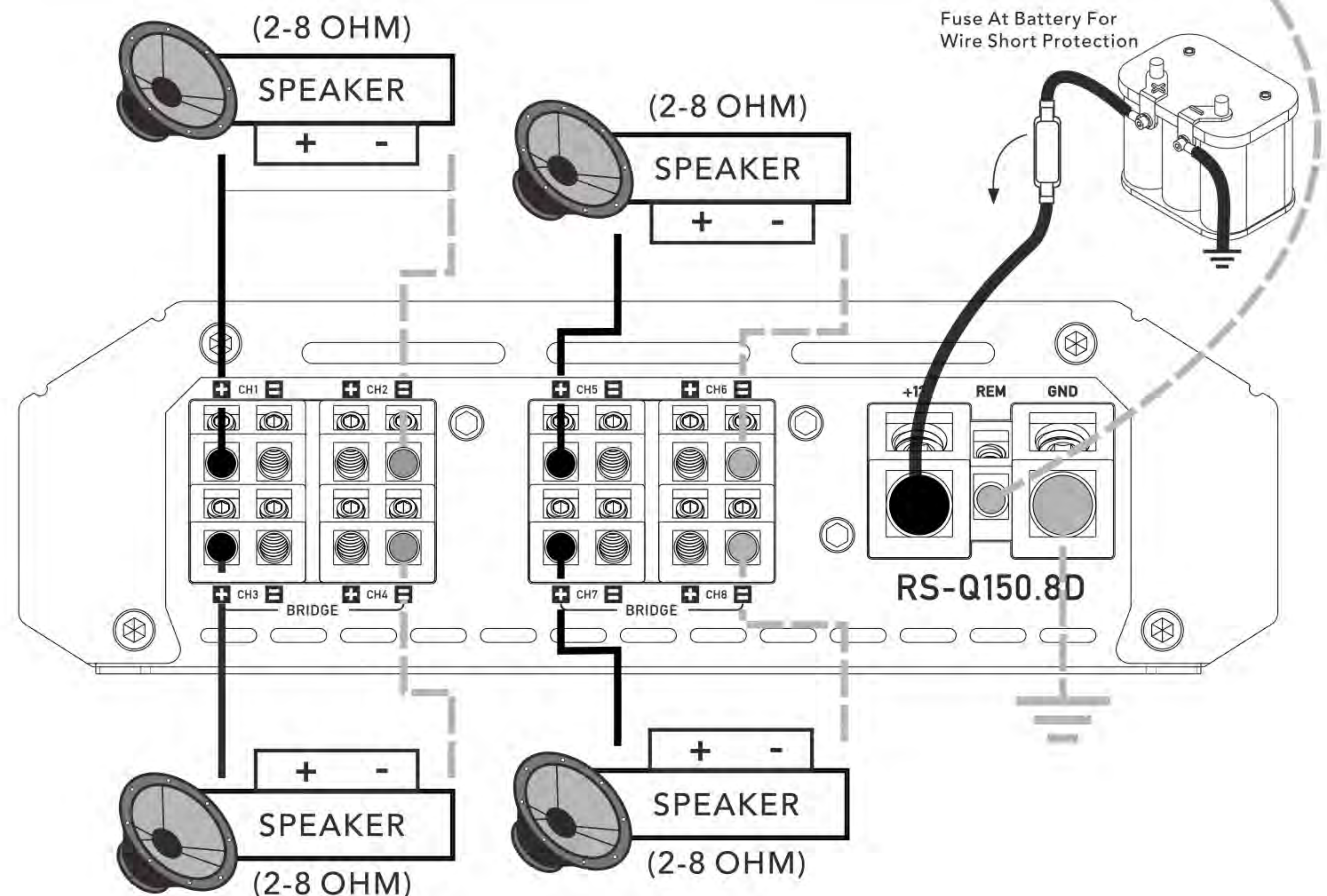
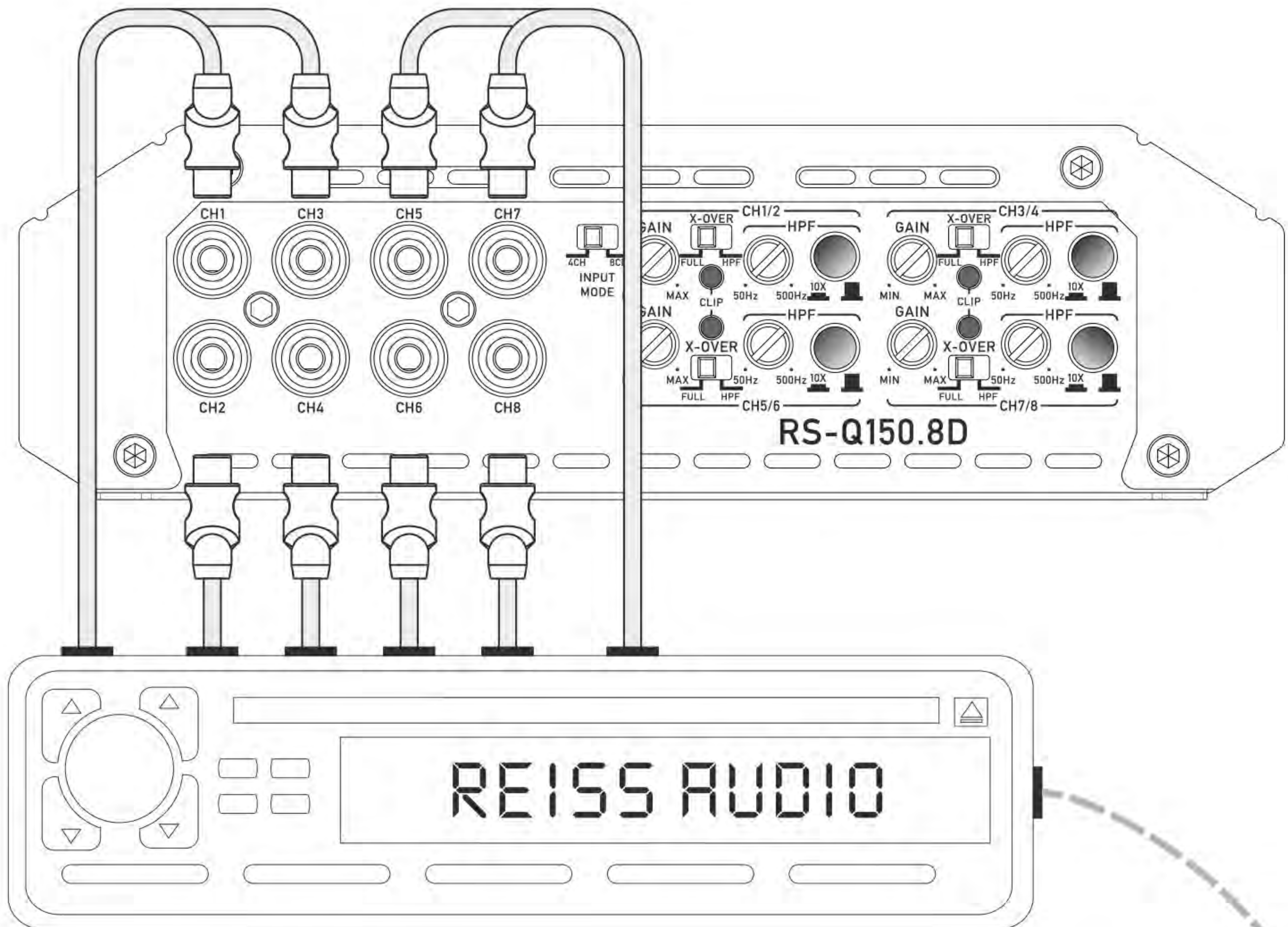

SPECIFICATIONS

MODEL NO.	RS-Q2500.1D	RS-Q700.4D1	RS-Q700.4D4	RS-Q150.8D
Circuit Topology	Mono Block Class-D	Full Range Class-D	Full Range Class-D	Full Range Class-D
RMS POWER OUTPUT AT 1 Ω	2500W	700Wx4CH	N/A	N/A
RMS POWER OUTPUT AT 2 Ω	1800W	500Wx4CH	1050Wx4CH	225Wx8CH
RMS POWER OUTPUT AT 4 Ω	1200W	300Wx4CH	700Wx4CH	150Wx8CH
RMS POWER OUTPUT AT 4 Ω BRIDGED	N/A	1000Wx2CH	2100Wx2CH	450Wx4CH
RMS POWER OUTPUT AT 2 Ω BRIDGED	N/A	1400Wx2CH	N/A	N/A
TOTAL HARMONIC DISTORTION	<0.3%	<0.3%	<0.3%	<0.3%
S/N RATIO REF 1W AT 4Ω	>90dB	>90dB	>90dB	>90dB
GAIN RANGE	0.2-10V	0.2-10V	0.2-10V	0.2-10V
PER OCTAVE SLOPES	24dB	12dB	12dB	12dB
OPAMP CHIPSET	JRC4580	JRC4580	JRC4580	JRC4580
CROSSOVER RANGE	50-250Hz	LPF:40-400Hz; HPF:40-400Hz / 400Hz-4KHz		HPF:50-5KHz(Multiple)
OPERATION FREQUENCY RANGE	20-500Hz	20-20KHz	20-20KHz	20-20KHz
SUBSONIC	10-55Hz	N/A	N/A	N/A
BASS BOOST	0-18dB	0-18dB	0-18dB	N/A
BASS KNOB	INCLUDED	N/A	N/A	N/A
INPUT MODE	N/A	2CH - 4CH	2CH - 4CH	4CH - 8CH
DIMENSIONS(MM)	308x180x53.3	368x180x53.3	498x180x53.3	308x180x53.3

TROUBLE SHOOTING

NO POWER LED ON, NO OUTPUT

- Check +12V, GND and remote connection
- Check the external fuses or built-in.

POWER LED ON, NO OUTPUT

- Check source unit for output
- Check input gain control
- Check RCA cable quality and connection
- Check speaker and wiring for shorts
- Check for damaged speakers

NO SOUND ON ONE CHANNEL

- Swap left/right input to check source
 - ... If sound swaps, source or signal cable is bad
- Swap left/right speaker to check speakers
 - ... If sound does not swap, speaker or speaker wiring is bad
 - ... In any case, consult authorized dealer

AMPLIFIER GOES IN PROTECTION MODE AT HIGHER GAIN

- Check speaker impedance.
- Check working voltages (9.0V - 16.0Volts)
- Check speaker wiring for short circuit

ENGINE OR ALTERNATOR WHINE NOISE

- Check wiring make sure RCA cables are not run parallel on same side of vehicle as power cable.
- Check any processors in the signal path between source unit and amplifier
- Make sure ground pin (shield or outer barrel of RCA cables) have not lost connection and that source unit has a good reference ground.

WARRANTY

Should your amplifier require service Please consult with the dealer from which it was purchased, or contact **REISS AUDIO** Local Dealer.

Do not attempt to return your amplifier directly to us without first calling for a Return Authorization Number. Units received without an accompanying Return Authorization Number will be processed more slowly. Additionally, you must include a copy of your purchase receipt from an authorized dealer for consideration of in-warranty service; otherwise repair charges will apply. Units received without a receipt will be held for 30 days, allowing us time to contact you and obtain a copy of the receipt. After 30 days, all units will be returned.

AMPLIFIER OWNER'S MANUAL



REISS and the REISS logo are registered trademarks of REIS ELETRONICS INC.
All other brand names are trademarks or registered trademarks of their respective owners.
All rights reserved. Designed in Turkey. Assembled in PRC.

