



OWNER'S MANUAL
XP 1200.4



| | |
|--------------------------------------|----|
| Introduction | 3 |
| Package contents | 3 |
| Safety instructions..... | 4 |
| Panels description | |
| Audio inputs and controls..... | 5 |
| Power inputs and audio outputs | 6 |
| Installation sequence | 7 |
| Electrical dimensioning..... | 8 |
| Audio inputs | |
| RCA inputs..... | 8 |
| High Level inputs..... | 8 |
| Wiring diagram | |
| Four channels wiring diagram | 9 |
| Three channels wiring diagram | 9 |
| Two channel wiring diagram..... | 10 |
| Procedure for setting the Gain | 10 |
| Crossovers set up..... | 11 |
| Battery connection diagram..... | 12 |
| Amplifier operational LEDs | 13 |
| Diagnostic table | 14 |
| Technical specifications | |
| Parameters | 15 |
| Dimensional data | 15 |
| Additional Information | 15 |

Dear Consumer,

Congratulations, you have just acquired a SounDigital product of the highest technology and quality, so we thank you for your trust.

SounDigital products are made with raw materials of the highest quality standards, and the most modern processes, equipment and technology are used in their production.

IMPORTANT INFORMATION

On this manual you will learn about the product, its features and characteristics, in order to obtain the best result and to be able to enjoy your music with SounDigital quality and power.









Read this manual carefully and follow precisely all the information contained therein, these are very important and allow your amplifier to work optimally. If you think it is necessary, please do not hesitate to contact our technical support at the following contact:

✉ **info@soundigitalusa.com**

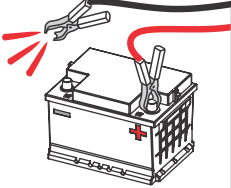
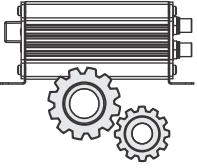
PACKAGE CONTENTS

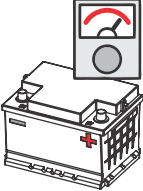
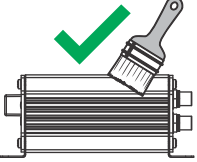
- 01 **XP 1200.4** Amplifier
- 01 Installation quick guide with warranty card
- 01 Allen wrench 2.0mm
- 01 Allen wrench 2.5mm
- 01 Allen wrench 3.0mm
- 02 Cables for high level input
- 01 Promotional sticker

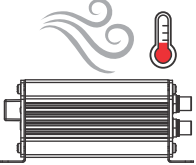
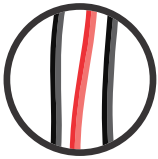
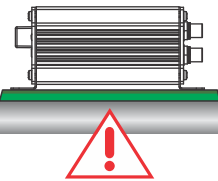
To avoid injury to the user or damage to the amplifier, read all safety instructions written on this manual.

| | |
|--|--|
| <p>The installation of this product must be done by a qualified professional. In case of any doubt, please contact our technical support;</p> |   <p>When passing cables through metallic walls, use rubber O-rings to avoid cable cutting and short-circuits;</p> |
| <p>Before proceeding with the installation of any electric equipment on your vehicle, unplug the negative (-) terminal of the battery to avoid fires, injuries or damages;</p> |   <p>Make sure that the chosen location for the amplifier installation does not affect the operation of the vehicle;</p> |
| <p>Use your sound system safely. The continuous exposure to sound pressures over 85dB may cause irreversible hearing damage;</p> |   <p>This product may reach temperatures over 60°C (140°F). Make sure it is cold before touching it;</p> |
| <p>This equipment is for use in automotive DC voltage batteries between 12.6 and 14.4 volts. Before installing the equipment, check voltage of the batteries;</p> |   <p>Clean the amplifier periodically with brush or dry cloth to assure the thermal efficiency of the heatsink;</p> |
| <p>Do not install the amplifier in places exposed to water, dirt or humidity;</p> |   <p>Be careful when making holes in the vehicle. Make sure you are not making holes in the fuel tank, brake lines or electrical cables of the vehicle;</p> |
| <p>Choose a ventilated place to install the amplifier and avoid blocking the side ventilation windows;</p> |   <p>Make sure the cables are properly secured throughout the installation;</p> |
| <p>Fix the amplifier properly and firmly. Avoid fixing to metallic parts of the vehicle, as this procedure may cause ground looping (noise);</p> |   <p>Wear gloves, safety glasses and all necessary PPE during the installation of SoundDigital amplifiers.</p> |



THIS "WARNING" SIGN ALERTS THE USER OF IMPORTANT INFO. NOT FOLLOWING THESE INSTRUCTIONS MAY CAUSE INJURIES TO THE USER OR DAMAGE TO THE EQUIPMENT.

Audio inputs and controls

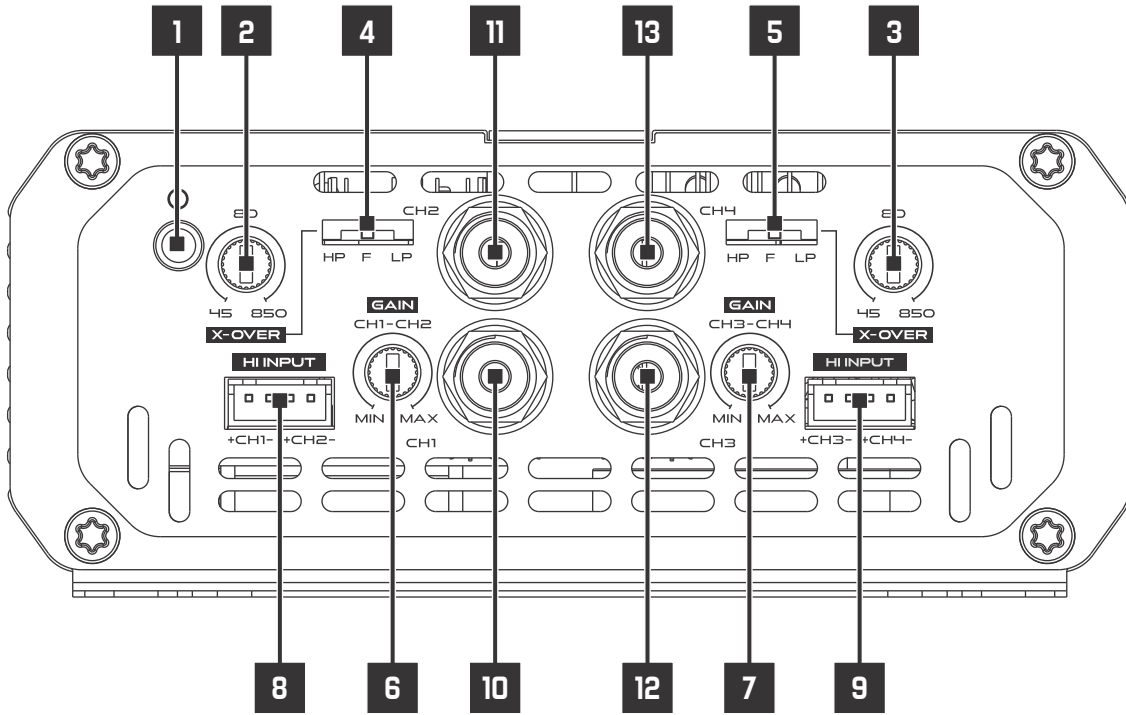

| | | |
|----|---------|---|
| 1 | Blue | "POWER ON" LED indicator |
| 2 | CH1/CH2 | Variable crossover control — 45Hz ~ 850Hz |
| 3 | CH3/CH4 | |
| 4 | CH1/CH2 | |
| 5 | CH3/CH4 | Crossover Switch High Pass — Full — Low Pass |
| 6 | CH1/CH2 | Variable Gain control |
| 7 | CH3/CH4 | |
| 8 | CH1/CH2 | Audio input — High Level (To connect to the speaker output of the head unit) |
| 9 | CH3/CH4 | |
| 10 | CH1 | Audio inputs — RCA connectors |
| 11 | CH2 | |
| 12 | CH3 | |
| 13 | CH4 | |

Power inputs and audio outputs

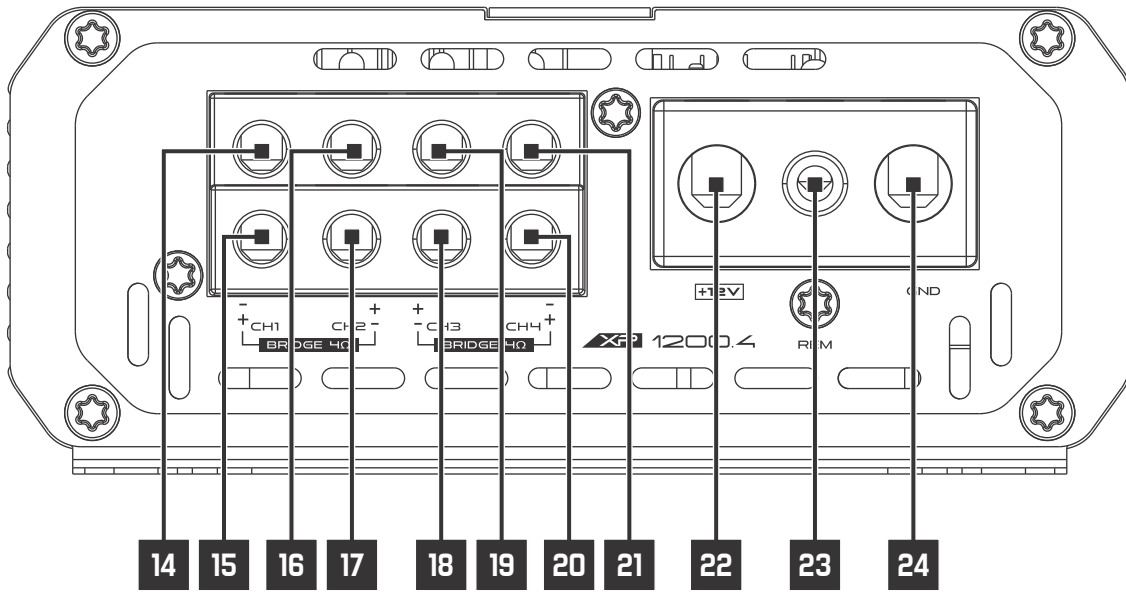

| | | |
|----|-----|--|
| 14 | CH1 | Negative speaker connector (-) |
| 15 | CH1 | Positive speaker connector (+) |
| 16 | CH2 | Positive speaker connector (+) |
| 17 | CH2 | Negative speaker connector (-) |
| 18 | CH3 | Negative speaker connector (-) |
| 19 | CH3 | Positive speaker connector (+) |
| 20 | CH4 | Positive speaker connector (+) |
| 21 | CH4 | Negative speaker connector (-) |
| 22 | - | Positive power supply connector (+12VDC) |
| 23 | - | Remote power supply connector (REM) |
| 24 | - | Negative power supply connector (GND) |



WARNING!

BEFORE PROCEEDING WITH THE INSTALLATION, UNPLUG THE NEGATIVE TERMINAL FROM ALL OF THE BATTERIES, TO AVOID FIRE, DAMAGE TO THE AMPLIFIER AND THE USER HIMSELF.

- Mount the amplifier in such a way you have access to the connectors;
- Install the power cables in the vehicle properly, starting from the battery to the fuse holder or circuit breaker, use the cable with the appropriate size. Make all connections, install fuse holders or circuit breakers, but without placing the fuses or with the circuit breakers in the "OFF" position;



WARNING!

THE MAXIMUM DISTANCE FOR THE INSTALLATION OF THE FUSE/CIRCUIT BREAKER IS 12 INCHES (30cm) AWAY FROM THE BATTERY.

- Connect the power cables in to the amplifier, observing the polarity. Connect all the positive cables (+) from the fuse holder or circuit breaker to the positive connector of the amplifier and all the negative power cables from the batteries to the negative connector of the amplifier;
- The ground cable must be as short as possible and must be connected to the vehicle chassis and the battery negative;

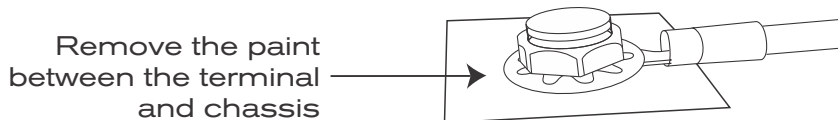

- Install the signal input cables in a proper way, distant from the power cables;
- Connect the RCA or the high level signal input cables to the head unit and amplifiers;
- Install the audio output cables with the appropriate section, distant from the power and audio input cables;
- Connect the audio output cables to the amplifier and speakers respecting the positive (+) and negative (-) polarities;
- Install the remote cable with the power cables, using 1.5mm² (15 AWG) cable or thicker;
- Connect the remote power cable to the amplifier's "REM" terminal at the main unit's remote power output (when not using the high level signal inputs);
- Before powering the system, verify all the connections and make sure there are no mistakes or short-circuits on the power and ground cables;
- Reconnect the ground of the batteries;
- Check if the head unit is turned off and then place the fuses in the fuse holders or switch the circuit breakers on;
- Turn on the main unit and the amplifier will turn on the "POWER ON" LED indicating that it is in operation.



WARNING!

Minimum recommended installation distance between amplifiers*.
1.18in. (30mm)

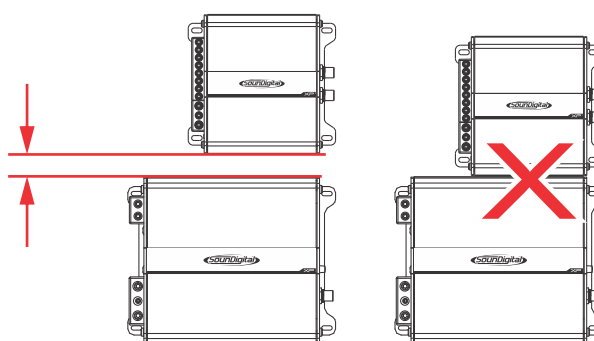

*For installations with more than one amplifier, second unit not included. Merely illustrative images.

ELECTRICAL DIMENSIONING

For proper operation of your SounDigital amplifier, you need the proper dimensioning of the electrical system and the cables used.

The table below shows the minimum section of GND cables, +12VDC cables and speaker output cables according to the power generated by the amplifier.

| | | |
|--------------|----------------------|-----------------------------|
| 1200 WRMS | POWER CABLE (+12VDC) | 16mm ² (5 AWG) |
| | GROUND CABLE (GND) | |
| | SPEAKER CABLE | 2.5mm ² (13 AWG) |
| | REMOTE CABLE | 1.5mm ² (15 AWG) |

We recommend the use of only OFC (Oxygen Free Copper) cables on the installation of our products.

Copper-clad aluminum wire (CCAW) must not be used.

AUDIO INPUTS

RCA inputs

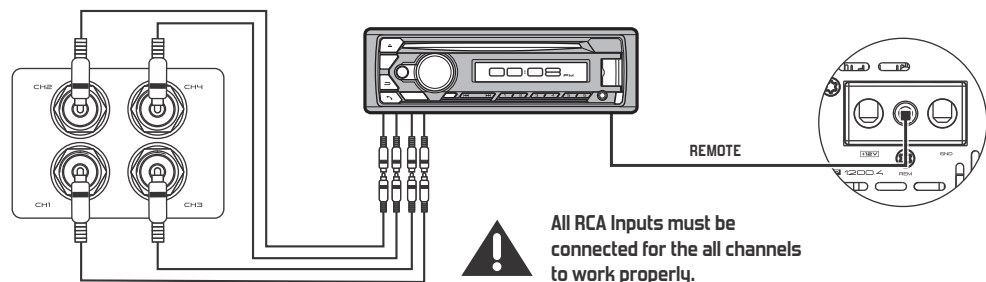

High level signal inputs

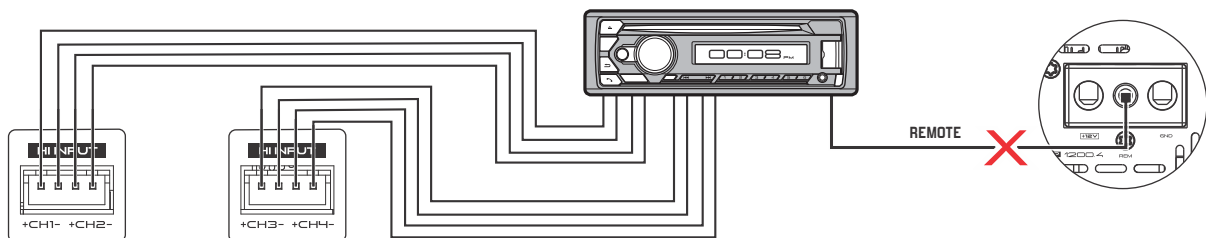

High level input must be used when the main unit does not have RCA outputs.

When High level inputs is used, no remote connection is required, the amplifier recognizes the audio signal and switches on.

If your source unit is not able to turn on the amplifier through the High level input, the remote input should be connected normally.



RCA AND HIGH LEVEL INPUTS SHOULD NOT BE USED SIMULTANEOUSLY OR YOU MAY DAMAGE THE AMPLIFIER.

2 CHANNELS WIRING DIAGRAM (BRIDGE)

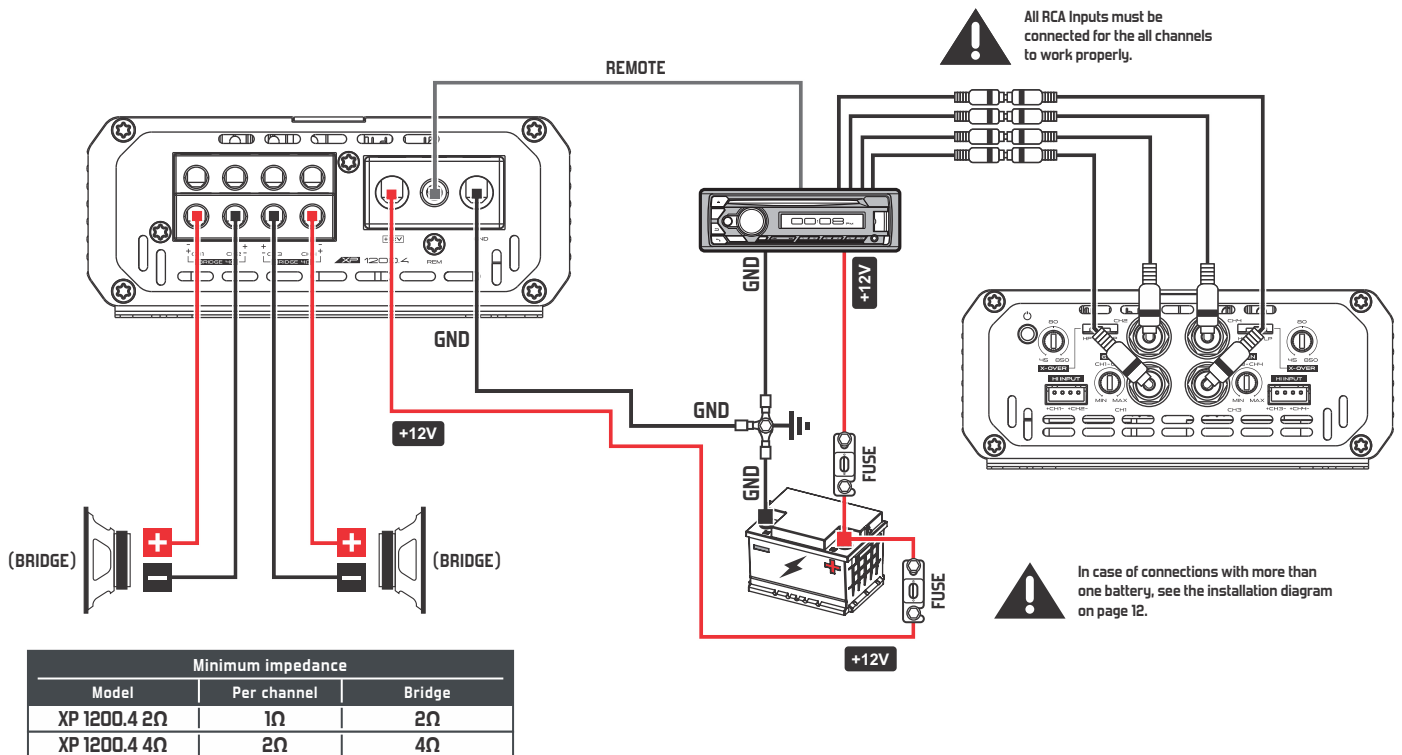

GAIN SETTING

Necessary equipment:

- Digital AC voltmeter;
- Media with sine wave test tone 60Hz recorded at 0db;
- Screwdriver 1/8" (for gain setting).

Set up procedure:

- This procedure is the same for both gain controls;
- Turn the gain control all the way down;
- Disconnect the output cables from the amplifier outputs;
- Turn off all processing (bass, treble, loudness, EQ, etc.);
- Set the audio player volume to 3/4 of full volume;

- Set the audio player fader control to center position (left and right fader controls);
- Set the crossover selector switch in "F";
- Use a 60 Hz sine wave;
- Connect the AC voltmeter to the speaker output connectors of the amplifier. Make sure you test the voltage at the correct connectors (+ and -);
- Increase the gain control until the target voltage is observed with the voltmeter (see the chart below);
- Once you have adjusted the amplifier to the correct voltage output, turn off the source unit and reconnect the speaker(s).

| MODEL | STEREO / POWER | BRIDGE / POWER | STEREO OUTPUT VOLTAGE | BRIDGE OUTPUT VOLTAGE |
|--------------|----------------|----------------|-----------------------|-----------------------|
| XP 1200.4 2Ω | 1Ω / 4 x 300W | 2Ω / 2 x 600W | 17.3V | 34.6V |
| XP 1200.4 4Ω | 2Ω / 4 x 300W | 4Ω / 2 x 600W | 24.5V | 49.0V |

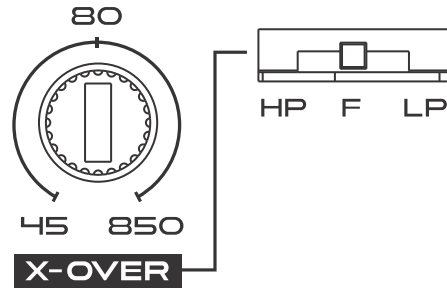

- "F" All the frequencies are reproduced;
- "LP " Set in the variable control on Low Pass Function;
- "HP " Set in the variable control on High Pass Function.

- Change the switch to "F" position (Full Range) - All the frequencies will be reproduced.

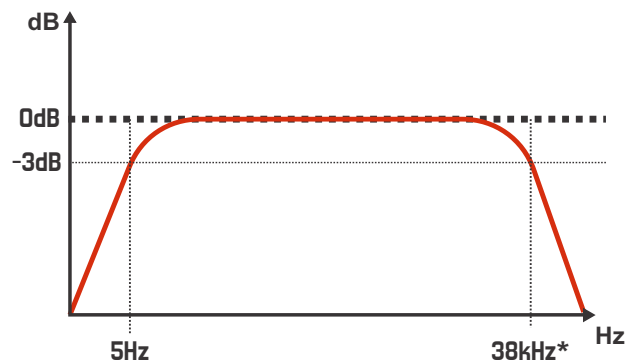

- Change the switch to "HP" position - Set in the variable control between 45Hz and 850Hz ("A") where you want to perform the high pass cut filter;

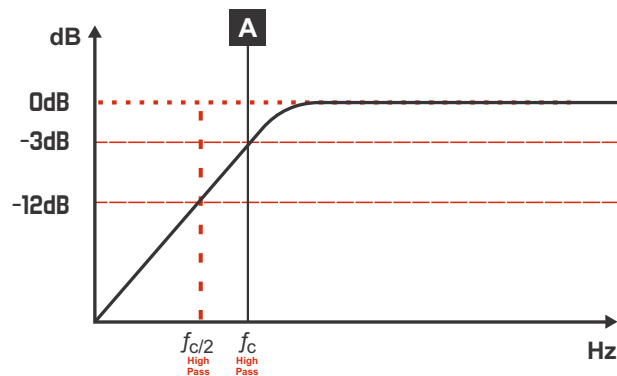

- Change the switch to "LP" position - Set in the variable control between 45Hz and 850Hz ("B") where you want to perform the low pass cut filter;

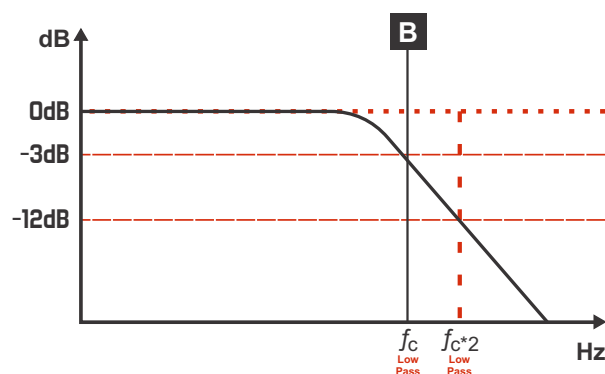

When necessary the association of one or more battery banks to supply the necessary current to the amplifier, it is recommended to use batteries of the same brand, model, and if possible the same manufacturing lot so that the system has the maximum performance.

For an ideal energy performance, we recommend that all batteries be connected to positive and negative busbars and the busbars connected to the amplifier, as shown in the diagram below:

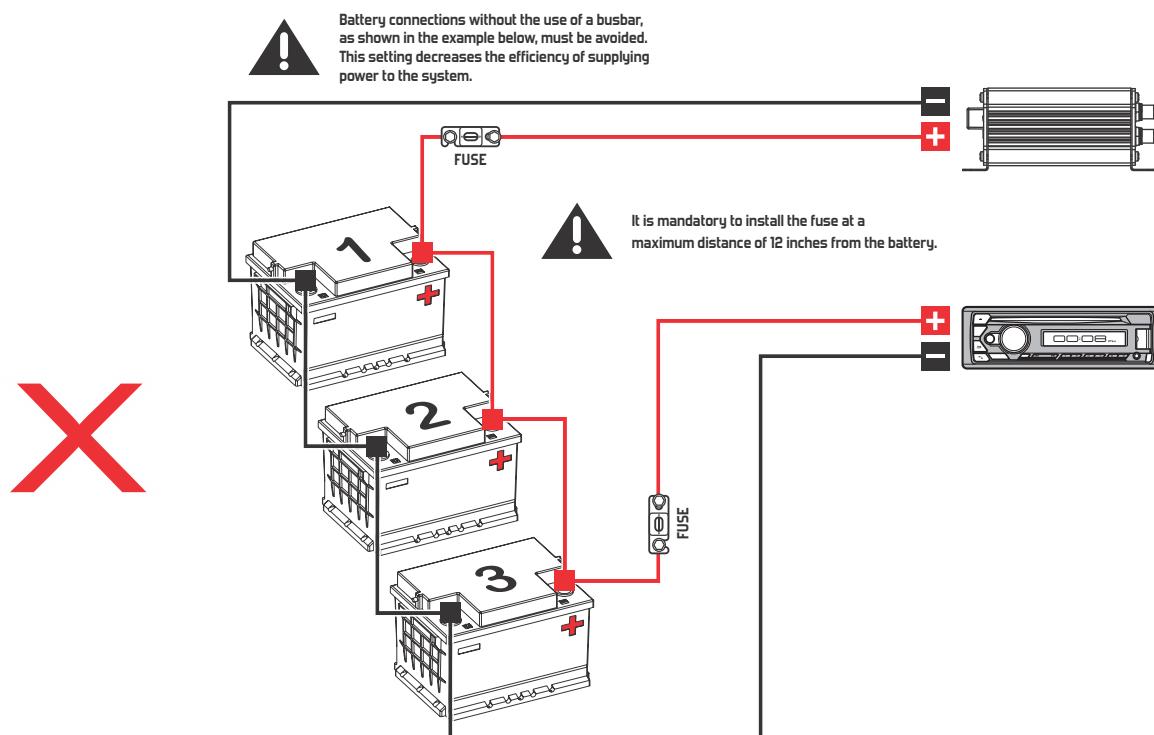
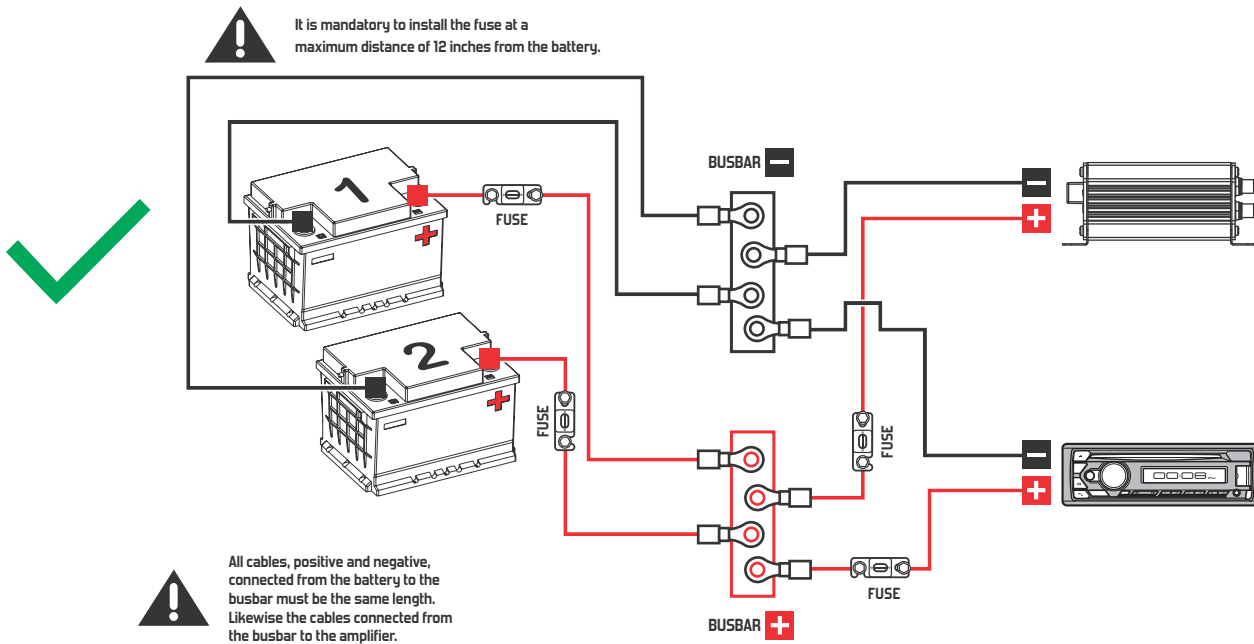

 **"POWER" LED indicator (blue)**

LED "POWER" Off..... Product off.

LED "POWER" On Product on.

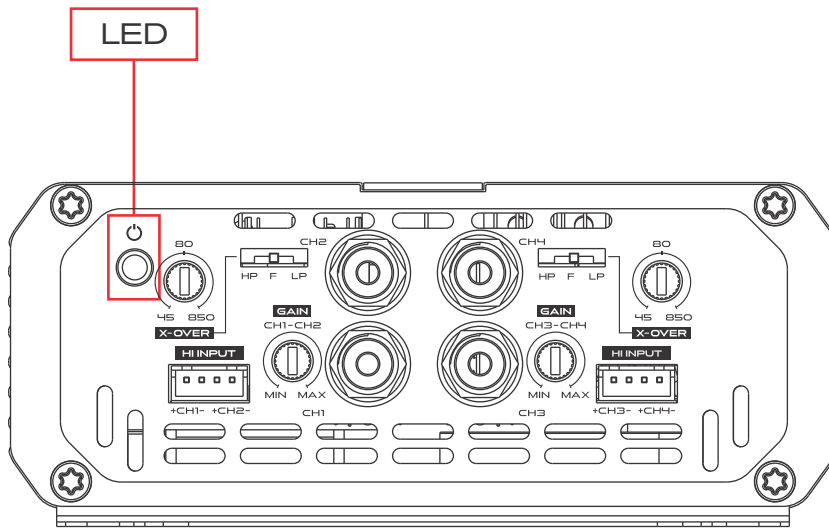

In the vast majority of cases, situations that at first glance appear to be a defect can be adjusted and resolved by yourself without the need to seek Authorized SoundDigital Technical Assistance. If the problem persists after carrying out the corrective actions below, contact our nearest technical team.

| APPARENT DEFECT | PROBABLE CAUSE | SOLUTION |
|---|---|---|
| Amplifier does not turn on. | Lack of power supply. | •Check if the power and remote signal cables are connected correctly. |
| When audio is cut off. | Low or very high supply voltage. | •Check the battery, cables and fuse holder of the installation. •Check that the battery and cables are sized as specified in the parameter table in this manual. |
| Abnormal noise from the speakers. | Ground fault. | •Check if there is a defective RCA cable, if the radio's RCA ground is open or if there is an external power source connected (source or charger). •Make sure the RCA cables are close to the vehicle's power cables or wiring harnesses. •Check that the vehicle's spark plug wires are suppressive. In many cases it is necessary to use capacitors in the alternator, horn and ignition. •Check the quality of the grounding and that there is no paint at the fixing point, if necessary, scrape it off. For fixing, use an eye terminal correctly sized for the cable. When using other amplifiers, ground each piece of equipment at the same point. |
| Popping noise in speakers when amplifier is turned on or off. | RCA ground fault. | •Check whether the car radio's RCA grounding or the RCA cable's grounding mesh are broken. |
| Weak bass. | Phase cancellation between speakers. | •Check if there is a reversal in the polarity of the connection between the speakers. |
| Amplifier turns on but there is no audio. | Input or output connection failed or no signal. | •Check the connection of the RCA cables and output cables. •Check the car radio volume, balance or fader settings and audio processor levels. |

| PARAMETERS | XP 1200.4 - 2Ω | XP 1200.4 - 4Ω |
|---|---------------------------------|---------------------------------|
| Power RMS @ 4Ω** | 4 x 131W | 4 x 198W |
| Power RMS @ 2Ω** | 4 x 198W | 4 x 300W |
| Power RMS @ 1Ω** | 4 x 300W | N/A |
| Power RMS (Bridge) @ 4Ω** | 2 x 396W | 2 x 600W |
| Power RMS (Bridge) @ 2Ω** | 2 x 600W | N/A |
| Frequency Response (-3dB) | 5Hz ~ 23kHz | 5Hz ~ 38kHz |
| High Pass filter (12dB/octave) | 45Hz ~ 850Hz | 45Hz ~ 850Hz |
| Low Pass filter (12dB/octave) | 45Hz ~ 850Hz | 45Hz ~ 850Hz |
| Bass Boost | N/A | N/A |
| Operating Voltage | 9V ~ 16V | 9V ~ 16V |
| SNR | 102dB | 104dB |
| Input Sensitivity (RCA) | 0.2V ~ 2V | 0.2V ~ 2V |
| Input Sensitivity (High Level input) | 1.5V ~ 15V | 1.5V ~ 15V |
| Current draw (music) | 48A | 48A |
| Current draw (max.) | 95A | 96A |
| Total Efficiency | 85% | 85% |
| Damping Factor (@100Hz nominal impedance) | 200 | 200 |
| Power cable | 16mm ² (5 AWG) | 16mm ² (5 AWG) |
| Speaker cable | 2 x 2.5mm ² (13 AWG) | 2 x 2.5mm ² (13 AWG) |
| Remote cable | 1.5mm ² (15 AWG) | 1.5mm ² (15 AWG) |
| Recommended Fuse* (music) | 60A | 60A |
| Recommended battery (minimum) | 60Ah | 60Ah |

*It is mandatory to install the fuse at a maximum distance of 12 inches from the battery.

**Power at 14.4V @ 60Hz with a maximum THD of 1%.



**POWER RATING ACCORDING TO CTA-2006 INDUSTRY STANDARDS.

DIMENSIONAL DATA

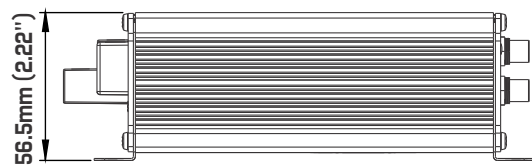
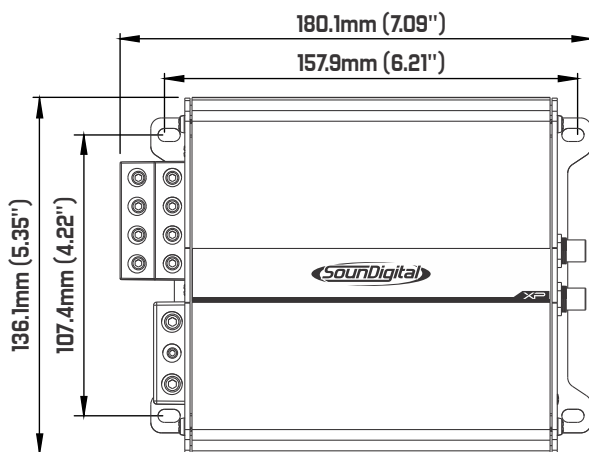

| NET WEIGHT* | GROSS WEIGHT* |
|-------------------|-------------------|
| 1.27 kg (2.79 lb) | 1.47 kg (3.24 lb) |

*Weights may vary slightly depending on the manufacturer.

ADDITIONAL INFORMATION

The values presented are based on measurements performed in SounDigital's laboratories. All the equipment used in the assays, tests, measurements and gauging of the technical parameters of SounDigital products were calibrated in certified laboratories, thus ensuring the performance and standard of excellence of the developed products.

The Manufacturing Process may present variations, and the electronic components may also present changes in values in relation to their nominal parameters. Thus, causing small differences between measurements taken. Small variations in the values presented and divulged by SounDigital are recognized.



Updates of information made in this document will always be published and made available for consumer consultation, free of charge, on the brand's websites. The user is advised to search for the manual in its latest version when necessary.

The images presented in this document are representative and merely illustrative; therefore, they do not necessarily correspond to the actual product/model.



AUDIO EXCELLENCE

Document revision code: 1000750739-002/DEC2025



Consumer
Technology
Association™



 WWW.SOUNDIGITAL.COM

  @SOUNDIGITAL

  @SOUNDIGITALUSA