



POWER SPORTS

OWNER'S MANUAL

800.1

EVO*PS*

Introduction	3
Package contents	3
Safety instructions.....	4
Technologies	
DTM®	5
Ultra compact PCB.....	5
Robust construction.....	5
I-Power Supply	5
VAS®	6
Marinization with protection index IP64	6
Assembling and Disassembling the Plastic Seals	7
Panels description	
Audio inputs and controls.....	8
Power inputs and audio outputs	9
Installation sequence.....	10
Electrical Dimensioning	11
Audio inputs	
RCA inputs.....	11
Bass Boost and Crossover set up.....	12
Wiring diagram	13
Procedure for setting the gain.....	14
Battery connection diagram.....	15
Technical specifications	
Parameters	16
Dimensional data	16
Additional Information	16

Dear Consumer,

Congratulations, you have just acquired a SounDigital product of the highest technology and quality, so we thank you for your trust.

SounDigital products are made with raw materials of the highest quality standards, and the most modern processes, equipment and technology are used in their production.

IMPORTANT INFORMATION

On this manual you will learn about the product, its features and characteristics, in order to obtain the best result and to be able to enjoy your music with SounDigital quality and power.

Read this manual carefully and follow precisely all the information contained therein, these are very important and allow your amplifier to work optimally. If you think it is necessary, please do not hesitate to contact our technical support at the following contact:

✉ info@soundigitalusa.com

FEATURES

- Resistant to moisture, water splash and dust;
- Compact design;
- Conformal coated PCB;
- Variable crossover controls;
- High efficiency Class D;
- Robust construction, resistant to vibrations and bumps;
- IP64 rating.





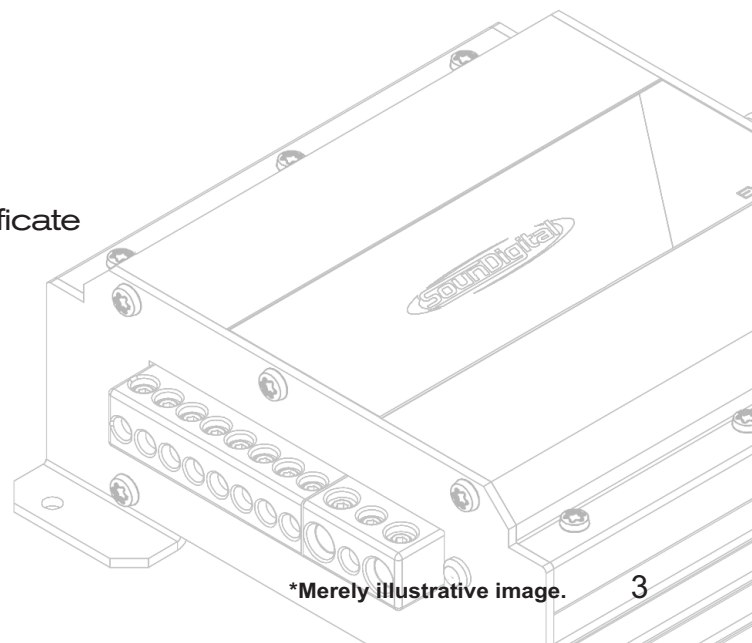

PACKAGE CONTENTS

- 01 **800.1 EVOPS** amplifier
- 01 Quick installation guide with warranty certificate
- 01 Allen wrench 2.5mm
- 01 Soundigital promotional black sticker
- 01 Soundigital promotional white sticker

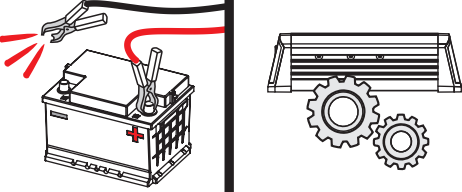

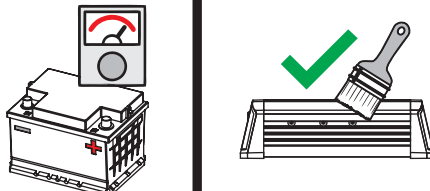
*Merely illustrative image.

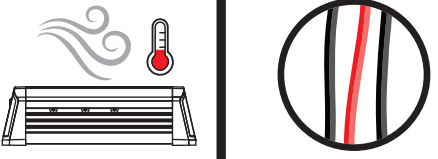
To avoid injury to the user or damage to the amplifier, read all safety instructions written on this manual.

<p>The installation of this product must be done by a qualified professional. In case of any doubt, please contact our technical support;</p>	 <p>When passing cables through metallic walls, use rubber O-rings to avoid cable cutting and short-circuits;</p>
<p>Before proceeding with the installation of any electric equipment on your vehicle, unplug the negative (-) terminal of the battery to avoid fires, injuries or damages;</p>	 <p>Make sure that the chosen location for the amplifier installation does not affect the operation of the vehicle;</p>
<p>Use your sound system safely. The continuous exposure to sound pressures over 85dB may cause irreversible hearing damage;</p>	 <p>This product may reach temperatures over 60°C (140°F). Make sure it is cold before touching it;</p>
<p>This equipment is for use in automotive DC voltage batteries between 12.6 and 14.4 volts. Before installing the equipment, check voltage of the batteries;</p>	 <p>Clean the amplifier periodically with brush or dry cloth to assure the thermal efficiency of the heatsink;</p>
<p>Do not install the amplifier in places exposed to water, dirt or humidity;</p>	 <p>Be careful when making holes in the vehicle. Make sure you are not making holes in the fuel tank, brake lines or electrical cables of the vehicle;</p>
<p>Choose a ventilated place to install the amplifier and avoid blocking the side ventilation windows;</p>	 <p>Make sure the cables are properly secured throughout the installation;</p>
<p>Fix the amplifier properly and firmly. Avoid fixing to metallic parts of the vehicle, as this procedure may cause ground looping (noise);</p>	 <p>Wear gloves, safety glasses and all necessary PPE during the installation of SoundDigital amplifiers.</p>



Warning!

THIS "WARNING" SIGN ALERTS THE USER OF IMPORTANT INFO. NOT FOLLOWING THESE INSTRUCTIONS MAY CAUSE INJURIES TO THE USER OR DAMAGE TO THE EQUIPMENT.

DYNAMIC THERMAL MANAGEMENT - DTM®

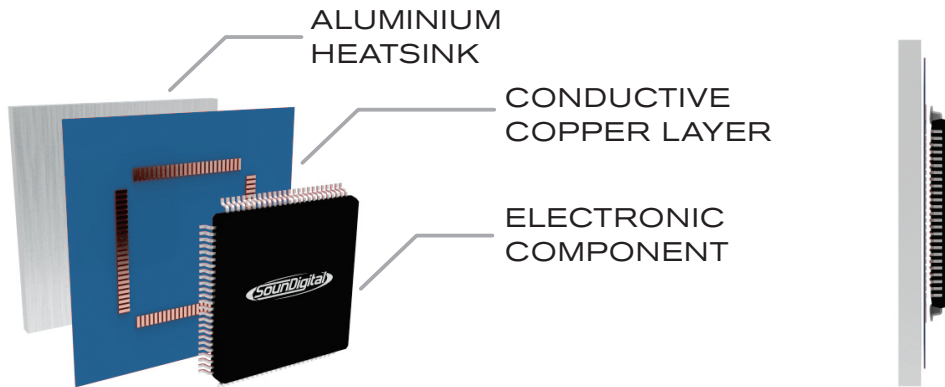

The **DTM** is a dynamic thermal recovery system which always maintains a high efficiency of the amplifier by accelerating the thermal exchange of electronic components with the heatsink.

**Patent required.*

ULTRA COMPACT PCB

An intelligent layout, with great use of the PCB area and the use of modern components with reduced structure guarantee **SounDigital** products a compact design, at the same time robust and with excellent thermal efficiency.

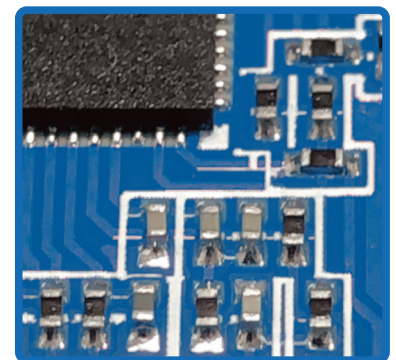

ROBUST CONSTRUCTION

Thinking about the application of power sports, the product has an extremely robust assembly, both the fixing points and the layout of the PCB were designed to withstand high vibrations, bumps and impacts.

I-POWER SUPPLY

SounDigital amplifiers are known for their low consumption of battery, and this feature stays on the **EVOPS Line**. The new **I-POWER SUPPLY** is even more modern, which replaces the old toroidal transformers by a new generation of "E-E" core transformers delivers efficiency above 90%*, ensuring more hours of sound without battery recharge.

**Efficiency measured at power supply only.*



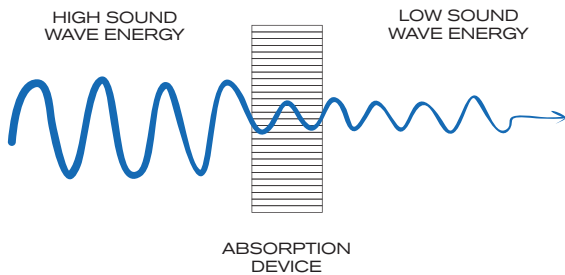

VIBRATION ABSORPTION SYSTEM - VAS®

Our **VAS®** Technology reduces all impact caused by vibration on the electronic circuit board. This can include road vibration and even vibration caused by sound waves, increasing the reliability of our amplifiers.

REDUCED SIZE

The technology used in our amplifiers bring both high performance and power a compact chassis, providing flexible installation solutions for vehicles with limited space.

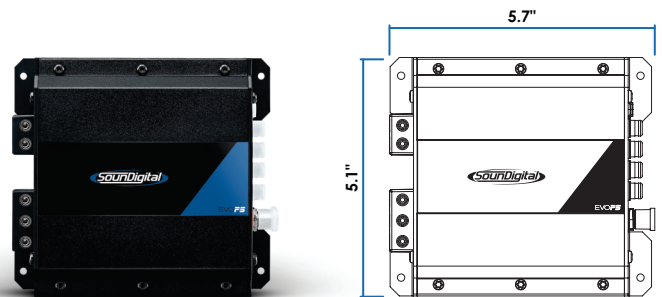

MARINIZATION WITH PROTECTION INDEX IP64

The product is protected against ingress of dust particles and water droplets from all sides, beyond that, the PCB receives a conformal coating treatment to protect the components from moisture.

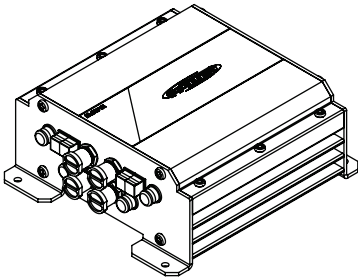
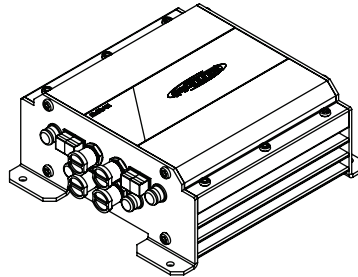
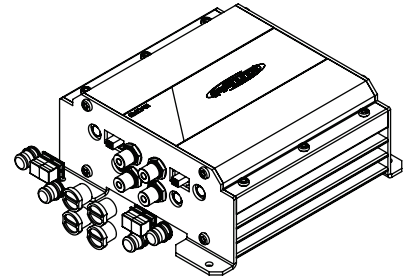

DISASSEMBLING THE PLASTICS SEALS**1****2****3**

- 1.** Squeeze the assembled Flexible Plastics Seals;
- 2.** Pull out the Plastics Seals.

*Merely illustrative images.

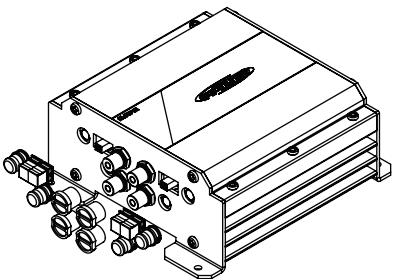
ASSEMBLING THE PLASTICS SEALS**1****2**

**RCA
Plastic Seal**



**Potentiometer
Plastic Seal**

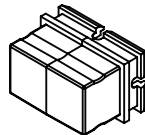

**Slide switch
Plastic Seal**

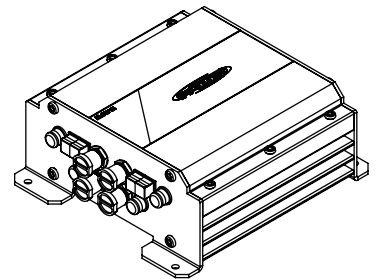
3

- 1.** Hold the disassembled Flexible Plastics Seals and fit them in their specific housing;
- 2.** Each connector has its specific Plastic Seal;
- 3.** Make sure the Flexible Plastics Seals are perfectly fitted.

*Merely illustrative images.

Audio inputs and controls

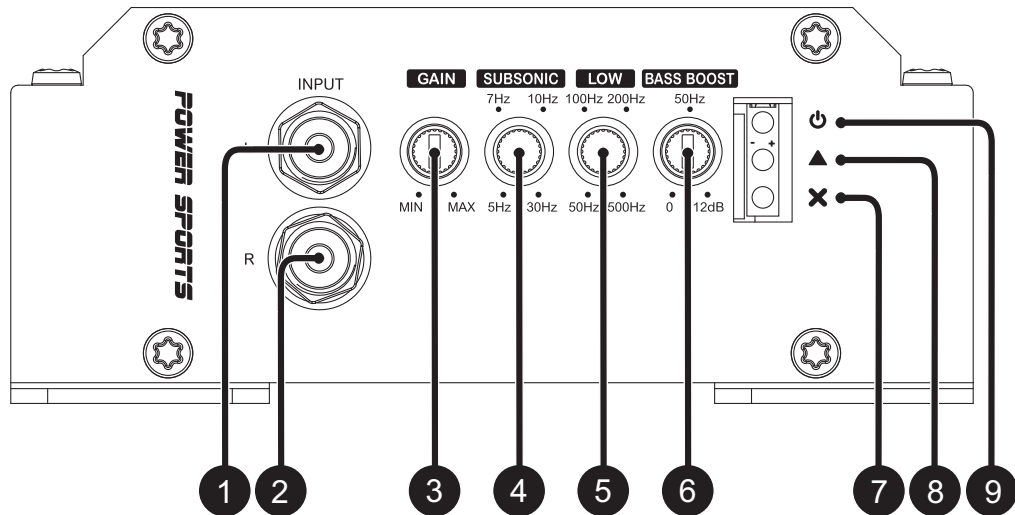

1	Left Channel	Audio inputs – RCA connectors
2	Right Channel	
3	-	Variable Gain Control
4	-	Variable "SUBSONIC" filter control (5Hz ~ 30Hz)
5	-	Variable "LOW" filter control (50Hz ~ 500Hz)
6	-	Variable "BASS BOOST" control 50Hz (0dB ~ +12dB)
7	Red	"PROTECTION" LED indicator
8	Yellow	"CLIP" LED indicator
9	Blue	"POWER ON" LED indicator

Power inputs and audio outputs

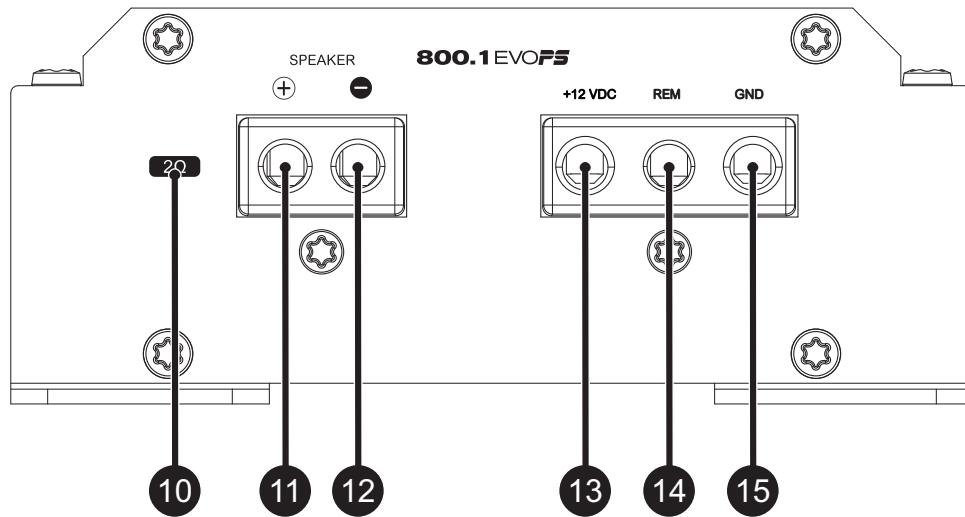

10	-	Minimum speaker load allowed (impedance)
11	Speakers output connectors	Positive speaker connector (+)
12		Negative speaker connector (-)
13	-	Positive power supply connector (+12VDC)
14	-	Remote power supply connector (REM)
15	-	Negative power supply connector (GND)

**Warning!**

BEFORE PROCEEDING WITH THE INSTALLATION, UNPLUG THE NEGATIVE TERMINAL FROM ALL OF THE BATTERIES, TO AVOID FIRE, DAMAGE TO THE AMPLIFIER AND THE USER HIMSELF.

- Mount the amplifier in such a way you have access to the connectors;
- Install the power cables in the vehicle/vessel properly, starting from the battery to the fuse holder or circuit breaker, use the cable with the appropriate size. Make all connections, install fuse holders or circuit breakers, but without placing the fuses or with the circuit breakers in the "OFF" position;

**Warning!**

THE MAXIMUM DISTANCE FOR THE INSTALLATION OF THE FUSE/CIRCUIT BREAKER IS 12 INCHES (30cm) AWAY FROM THE BATTERY.

- Connect the power cables in to the amplifier, observing the polarity. Connect all the positive cables (+) from the fuse holder or circuit breaker to the positive conector of the amplifier and all the negative power cables from the batteries to the negative connector of the amplifier;
- The ground cable must be as short as possible and must be connected to the negative connector of battery or vehicle chassis in case of metallic chassis;

Remove the paint
between the terminal
and chassis

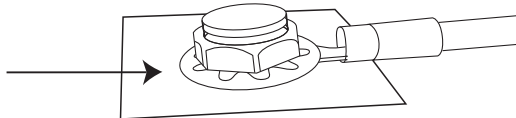

- Install the signal input cables in a proper way, distant from the power cables;
- Connect the RCA cables to the head unit and amplifiers;
- Install the audio output cables with the appropriate section, distant from the power and audio input cables;
- Connect the audio output cables to the amplifier and speakers respecting the positive (+) and negative (-) polarities;
- Install the remote cable with the power cables, using 1.5mm² (15 AWG) cable or thicker;
- Connect the remote power cable to the amplifier's "REM" terminal at the main unit's remote power output;
- Before powering the system, verify all the connections and make sure there are no mistakes or short-circuits on the power and ground cables;
- Reconnect the ground of the batteries;
- Check if the head unit is turned off and then place the fuses in the fuse holders or switch the circuit breakers on;
- Turn on the main unit and the amplifier will turn on the "POWER ON" LED indicating that it is in operation.

**Warning!**

Minimum recommended
installation distance
between amplifiers*.
1.18in (30mm)

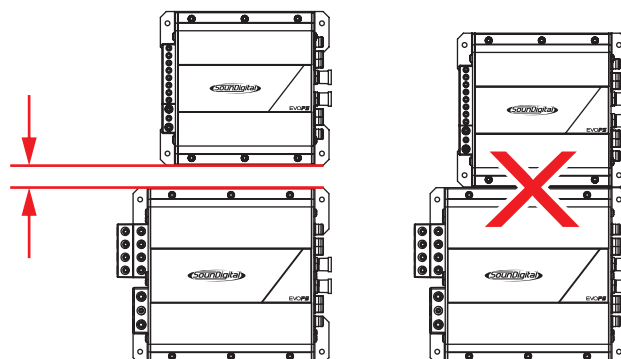

*For installations with more than one amplifier, second unit not included. Merely illustrative images.

ELECTRICAL DIMENSIONING

For proper operation of your SounDigital amplifier, you need the proper dimensioning of the electrical system and the cables used.

The table below shows the minimum section of GND cables, +12VDC cables and speaker output cables according to the power generated by the amplifier.

800 WRMS	POWER CABLE (+12VDC)	10mm ² (7AWG)
	GROUND CABLE (GND)	
	SPEAKER CABLE	2mm ² (14 AWG)

We recommend the use of only OFC (Oxygen Free Copper) cables on the installation of our products.

Copper-clad aluminum wire (CCAW) must not be used.

AUDIO INPUTS

RCA inputs

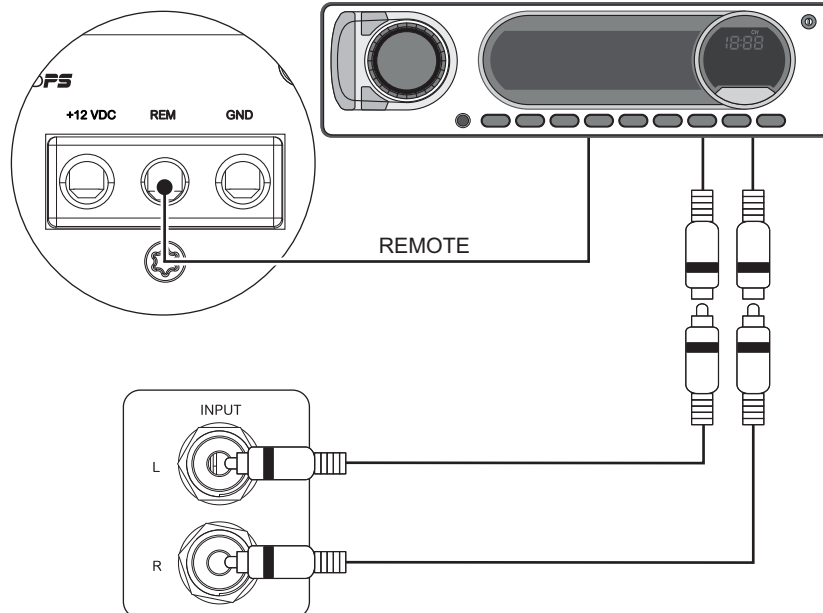

Using Bass Boost

The Amplifier Bass Boost setting enables the user to boost the sound intensity at low frequencies of the sound system, where boost intensity can be adjusted.

This is a semi-parametric equalizer type circuit with "Q" value for the fixed filter, with an intensity boost adjustment from 0 to +12dB (16 times), and a central frequency adjustment of the filter in 50Hz, making it versatile for several types of sound systems.

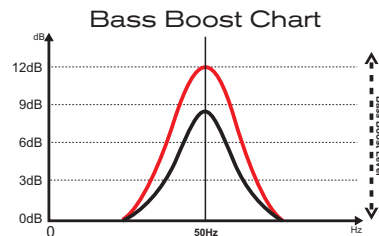

How to Adjust Bass Boost

Reproduce your favorite song and set the boost intensity between 0dB and +12dB at the variable control level according your preference.

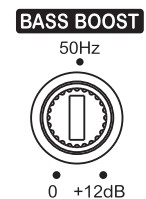

How to Adjust the Crossovers

The use of the two associated filters can form a bandpass filter, as in the figure below, where the point "A" is defined in the "SUBSONIC" crossover and the point "B" is defined in the "LOW" crossover.

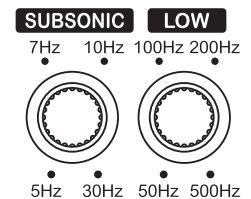
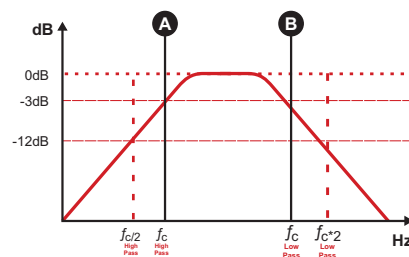

To set the "SUBSONIC" variable control between 5Hz and 30Hz ("A") where you want to perform the subsonic cut filter;

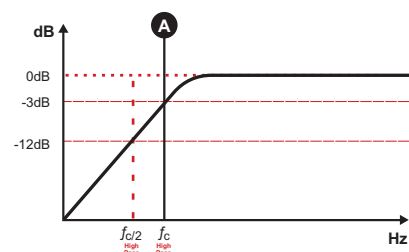

Set in the "LOW" variable control between 50Hz and 500Hz ("B") where you want to perform the low pass cut filter;

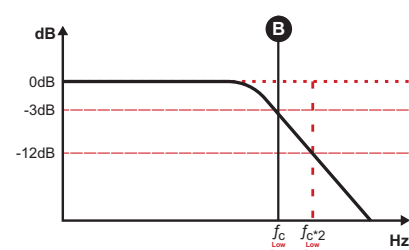

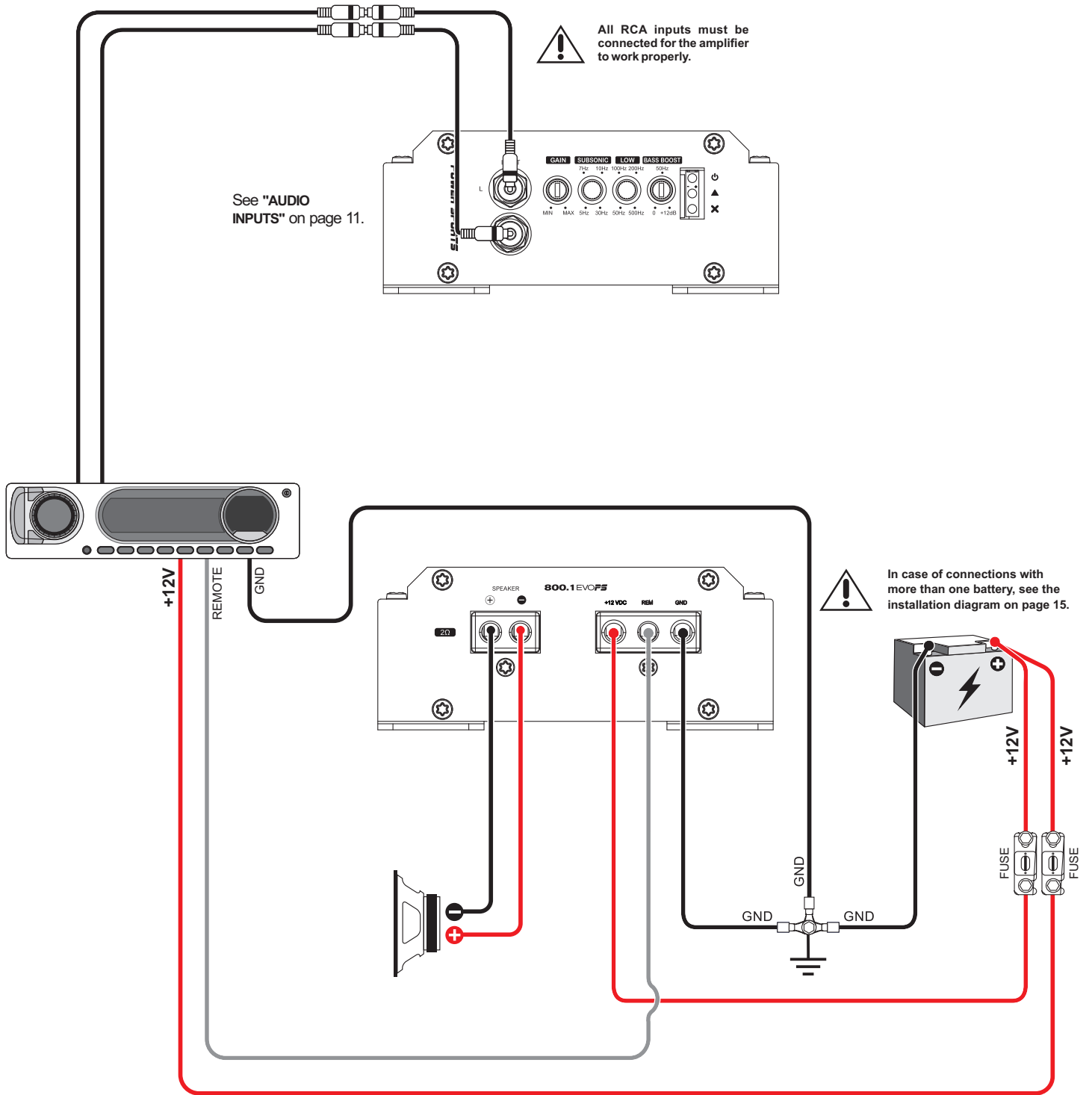

Model	Minimum impedance
800.1 EVOPS 4Ω	4Ω
800.1 EVOPS 2Ω	2Ω

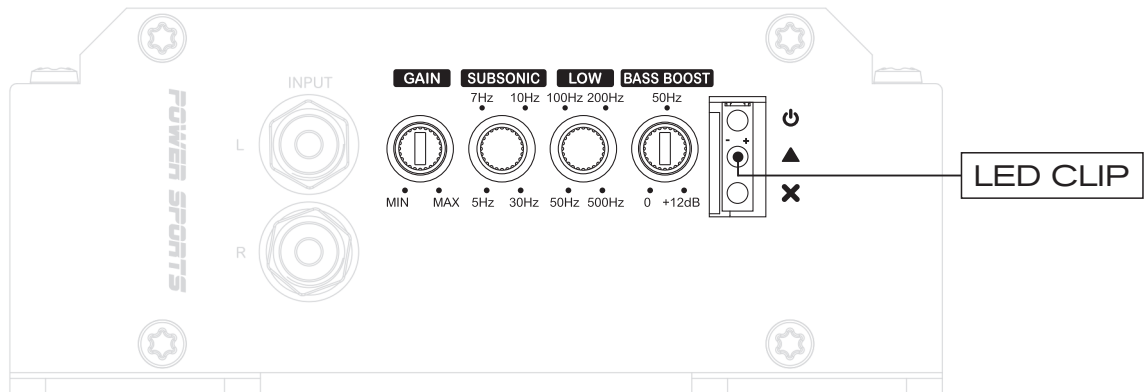

GAIN SETTING

Necessary equipment:

- Digital AC voltmeter;
- Media with sine wave test tone 60Hz recorded at 0db;
- 1/8" screwdriver (for gain adjustment).

Set up procedure

- Turn the gain control all the way down;
- Disconnect the output cables from the amplifier outputs;
- Turn off all processing (bass, treble, loudness, EQ, etc.);
- Set the source unit volume to 3/4 of full volume;
- Set the audio player fader control to center position (left and right fader controls);
- Set the variable "LOW" crossover in 500Hz;
- Set the variable "SUBSONIC" crossover in 5Hz;
- Use a 60 Hz sine wave;
- Increase the gain control until the "CLIP" LED starts blinking;
- Return the gain to the limit where the "CLIP" LED stops blinking and remains off;
- Once you have adjusted the amplifier to its correct voltage output, turn off the source unit and reconnect the speaker(s).

Download the tracks for set up in <https://soundigitalusa.com/tracks-for-set-up/>

When necessary the association of one or more battery banks to supply the necessary current to the amplifier, it is recommended to use batteries of the same brand, model, and if possible the same manufacturing lot so that the system has the maximum performance.

For an ideal energy performance, we recommend that all batteries be connected to positive and negative busbars and the busbars connected to the amplifier, as shown in the diagram below:

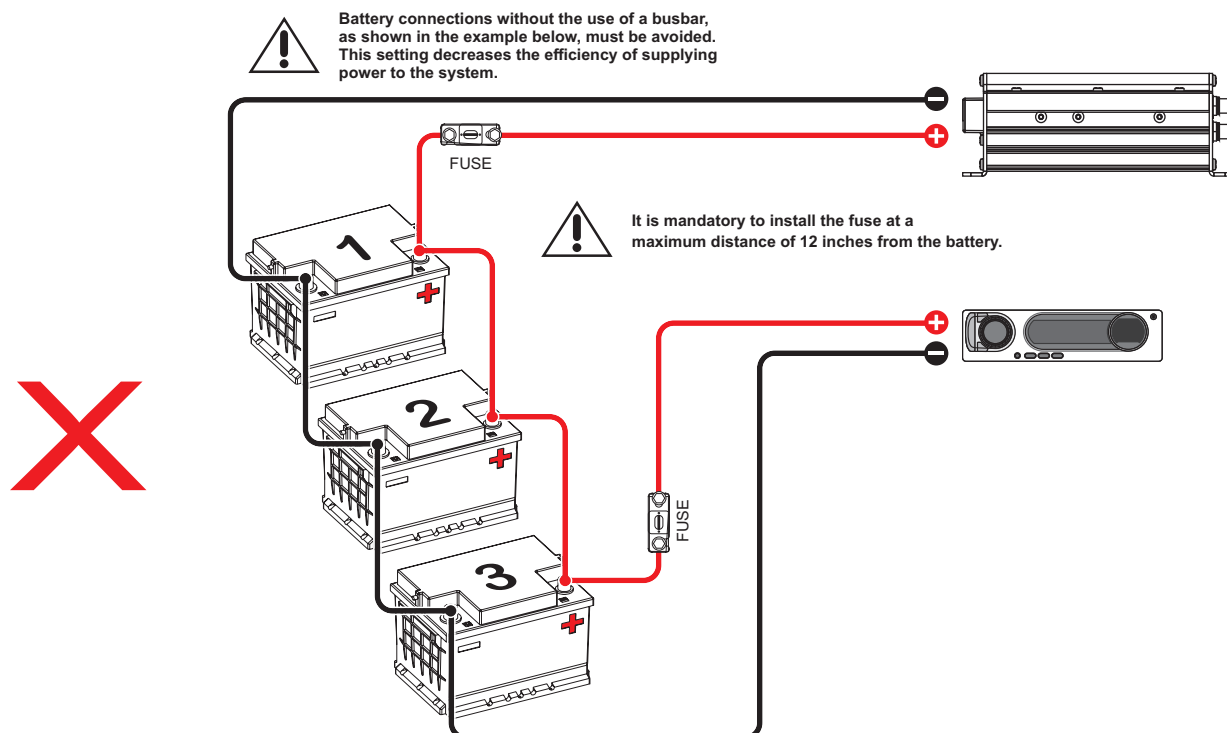
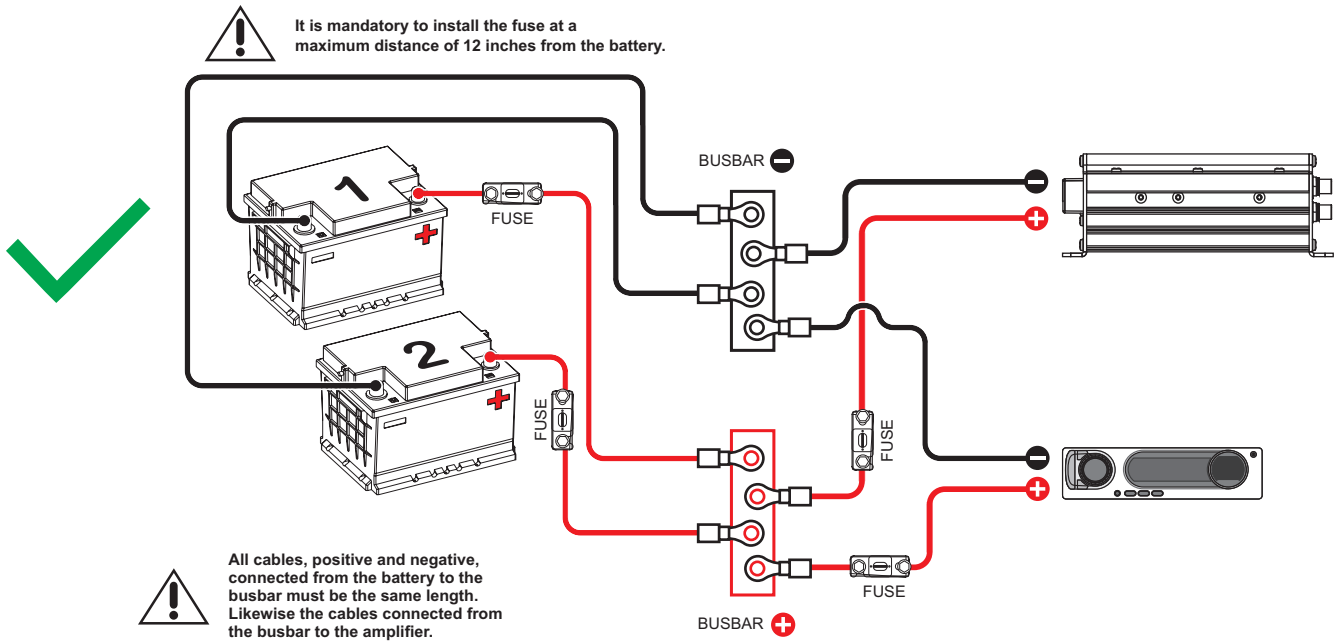

PARAMETERS	800.1 EVOFS 2Ω	800.1 EVOFS 4Ω
Power RMS @ 8Ω**	348W	528W
Power RMS @ 4Ω**	528W	800W
Power RMS @ 2Ω**	800W	N/A
Frequency Response (-3dB)	5Hz ~ 500Hz	5Hz ~ 500Hz
Subsonic filter (12dB/octave)	5Hz ~ 30Hz	5Hz ~30Hz
Low Pass filter (12dB/octave)	50Hz ~ 500Hz	50Hz ~ 500Hz
Bass Boost	0dB ~ 12dB @ 50Hz	0dB ~ 12dB @ 50Hz
Operating Voltage	9V ~ 16V	9V ~ 16V
SNR	90dB	90dB
Input Sensitivity (RCA)	0.2V ~ 4V	0.2V ~ 4V
Input Sensitivity (High Level input)	N/A	N/A
Current Draw (music)	32A	32A
Current Draw (max.)	65A	65A
Total Efficiency	85%	85%
Damping Factor (@100Hz nominal impedance)	200	200
Power Cable	10mm ² (7 AWG)	10mm ² (7 AWG)
Speaker Cable	2 x 2mm ² (14 AWG)	2 x 2mm ² (14 AWG)
Remote Cable	1.5mm ² (15 AWG)	1.5mm ² (15 AWG)
Recommended Fuse* (music)	40A	40A
Recommended Battery (minimum)	60Ah	60Ah

*It is mandatory to install the fuse at a maximum distance of 12 inches from the battery.

**Power at 14.4V @ 60Hz with a maximum THD of 1%.



**POWER RATING ACCORDING TO CTA-2006 INDUSTRY STANDARDS.

DIMENSIONAL DATA

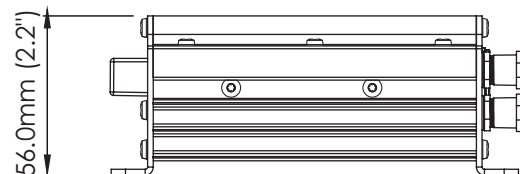
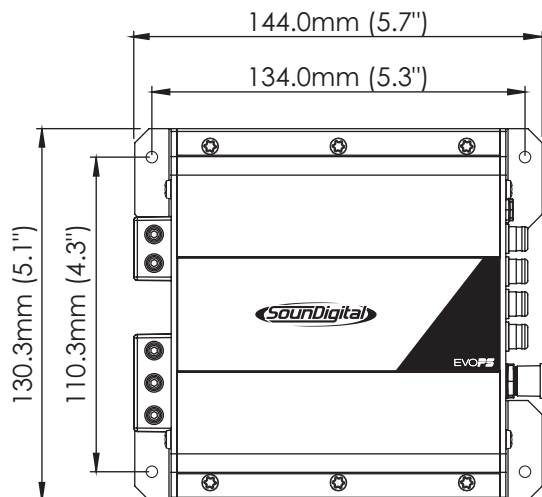

Net Weight	0.85 kg (1.87 lb)
Gross Weight	0.99 kg (2.18 lb)

ADDITIONAL INFORMATION

The values presented are based on measurements performed in SoundDigital's laboratories. All the equipment used in the assays, tests, measurements and gauging of the technical parameters of SoundDigital products were calibrated in certified laboratories, thus ensuring the performance and standard of excellence of the developed products.

The Manufacturing Process may present variations, and the electronic components may also present changes in values in relation to their nominal parameters. Thus, causing small differences between measurements taken. Small variations in the values presented and divulged by SoundDigital are recognized.



Updates of information made in this document will always be published and made available for consumer consultation, free of charge, on the brand's websites. The user is advised to search for the manual in its latest version when necessary.

The images presented in this document are representative and merely illustrative; therefore, they do not necessarily correspond to the actual product/model.



POWER SPORTS

EVOPS

Document revision code: 1000750357-002/MAR2024



Consumer
Technology
Association™



WWW.SOUNDIGITALUSA.COM



[SOUNDIGITALUSA](https://www.facebook.com/SOUNDIGITALUSA)



[SOUNDIGITALUSA](https://www.instagram.com/SOUNDIGITALUSA)