



DVD-USB-SD CARD PLAYER



MANUALE ISTRUZIONI
INSTRUCTIONS MANUAL
NOTICE DE MONTAGE ET D'EMPLOI
GEBRAUCHSANWEISUNGEN
MANUAL DE INSTRUCCIONES

ITALIANO

ENGLISH

FRANÇAIS

DEUTSCH

ESPAÑOL

VM072

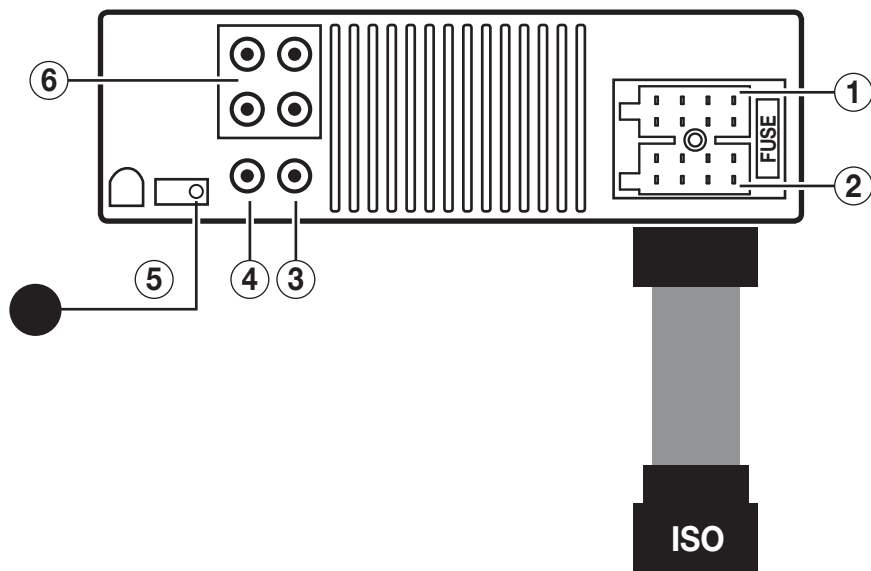

- | | |
|--------------------------|----------------------|
| 1. Alimentazione | 1. Power |
| 2. Uscita altoparlanti | 2. Speakers output |
| 3. Uscita video | 3. Video output |
| 4. Uscita Sub-Woofer | 4. Sub-Woofer output |
| 5. IR Esterno | 5. External IR |
| 6. Uscite preamplificate | 6. Pre-amp output |

1 ALIMENTAZIONE / POWER-SUPPLY

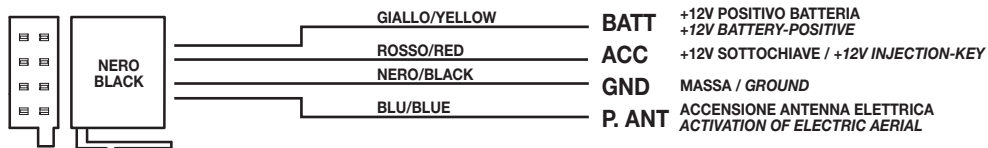

2 USCITE ALTOPARLANTI / SPEAKERS OUTPUT

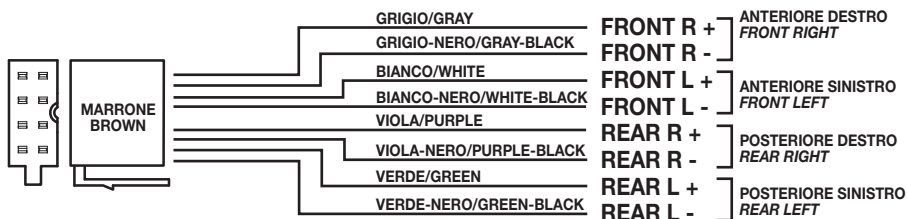

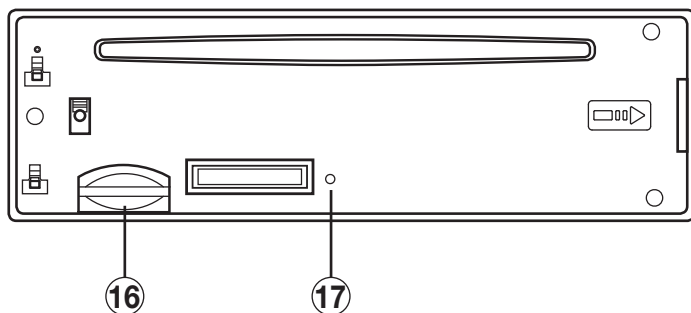

1. Espulsione disco
2. ⏮ ⏭ Traccia precedente / successiva
3. SRC Sorgente
4. DISCO / USB Selezione
5. Tasto sgancio frontalino
6. Accensione/Spegnimento ON/OFF
7. ▶|| Play / Pause / Intro
8. RPT / RDM Ripeti / Riproduzione casuale
9. Bilanciamento audio
10. DISPLAY/ MUTE Silenzia audio
11. Ingresso AUX-IN
12. Porta USB
13. Display
14. Feritoia disco
15. Controllo volume / Menù
16. Slot SD Card
17. Tasto impostazioni di fabbrica RESET

1. Disc eject
2. ⏮ ⏭ Previous / Next Track
3. SRC Source
4. DISC / USB Select
5. Release
6. Switch ON/OFF
7. ▶|| Play/Pause / Intro
8. RPT / RDM Repet / Random
9. BALANCE
10. DISPLAY/ MUTE
11. AUX-IN input
12. USB-port
13. Display
14. Disc slot
15. Volume adjustment / Menu
16. SD Card slot
17. Reset

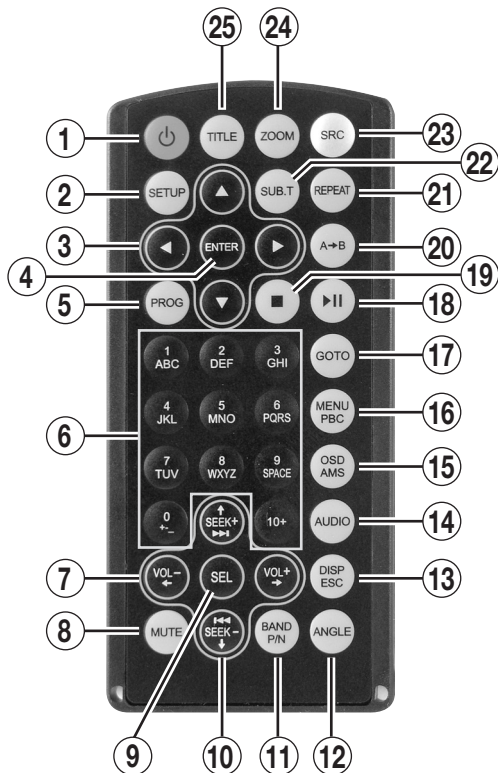

1. **POWER** Accensione/Spegnimento
2. **SETUP** Impostazioni generali
3. **◀▶▼▲** Tasti direzionali
4. **ENTER** Conferma
5. **PROG** Lista programmi
6. Tasti numerici
7. **VOL+ / VOL-** Regolazione volume
8. **MUTE** Volume azzerato
9. **NON ABILITATO**
10. **◀◀ ▶▶** Traccia precedente o successiva
11. **NON ABILITATO**
12. **NON ABILITATO**
13. **NON ABILITATO**
14. **AUDIO** Informazioni audio
15. **OSD/AMS** Informazioni riproduzione
16. **MENU PBC** Menù DVD
17. **GOTO** Selezione rapida traccia
18. **▶||** Riproduzione / Pausa
19. **■** Stop riproduzione
20. **A+B** Ripete capitolo
21. **REPEAT** Ripete traccia
22. **SUB.T.** Sottotitoli DVD
23. **SRC** Seleziona sorgente
24. **ZOOM** Regolazione
25. **NON ABILITATO**

1. **POWER** Switch-on/Switch-off
2. **SETUP**
3. **◀▶▼▲** Direction Keys
4. **ENTER** Confirmation
5. **PROG** Program list
6. Number-keys
7. **VOL+ / VOL-**
8. **MUTE**
9. **NOT AVAILABLE**
10. **◀◀ ▶▶** Previous/Next track
11. **NOT AVAILABLE**
12. **NOT AVAILABLE**
13. **NOT AVAILABLE**
14. **AUDIO** Audio info
15. **OSD/AMS** Track info
16. **MENU/PBC** Menù DVD
17. **GOTO**
18. **▶||** Playback/Pause
19. **■** Stop playback
20. **A+B** Chapter repeat
21. **REPEAT** Repeat track
22. **SUB.T.** DVD Subtitles
23. **SRC** Select Source
24. **ZOOM**
25. **NOT AVAILABLE**



Premere il tasto (SETUP) sul Telecomando.
 Utilizzare i tasti ▼ / ▲ per posizionarsi sulla funzione desiderata e premere il tasto ENTER per confermare e SETUP per uscire.

*Press SETUP-key on the Remote-Control unit.
 Use key ▼ / ▲ to move to the requested function. Now confirm selection by pressing ENTER. To quit, press SETUP-key.*

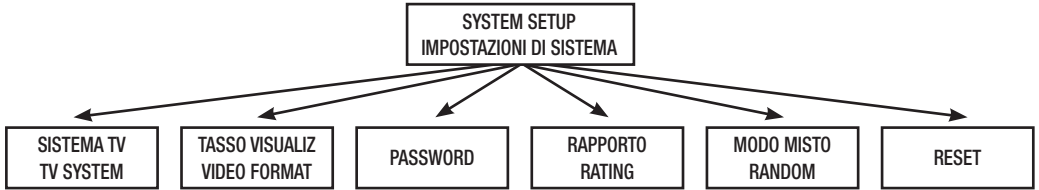

MENU IMPOSTAZIONI 1

Premere brevemente la manopola per accedere al menù impostazioni 1.
 Premere brevemente la manopola per scorrere il menù e ruotarla per modificare i valori.

SETTINGS MENU 1

*Briefly press the knob for entering the settings menu 1.
 Briefly press the knob for scrolling the menu and turn it, in order to change the values.*

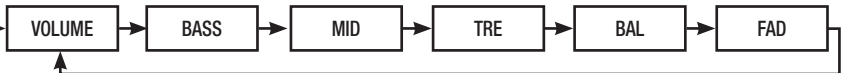

MENU IMPOSTAZIONI 2

Premere per 3 secondi la manopola per accedere al menù impostazioni 2.
 Premere brevemente la manopola per scorrere il menù e ruotarla per modificare i valori.

MENU SETTINGS 2

*Press the knob for 3 sec. for entering the settings menu 2.
 Briefly press the knob for scrolling the menu and turn it, in order to change the values.*



In assenza del disco, inserire il dispositivo USB/SD nell'apposita apertura. Il lettore cercherà automaticamente i file presenti sul supporto.

Nota: il funzionamento USB/SD è valido soltanto per la memoria volatile (flash). I formati compatibili sono: MP3, WMA, MPEG-4.

Free from CDs, insert the USB/SD-support into the related Port. The Player will automatically search the files available on the related support.

Please note: USB/SD-function works only referred to Flash-memory. Compatible Formats: MP3, WMA, MPEG-4.

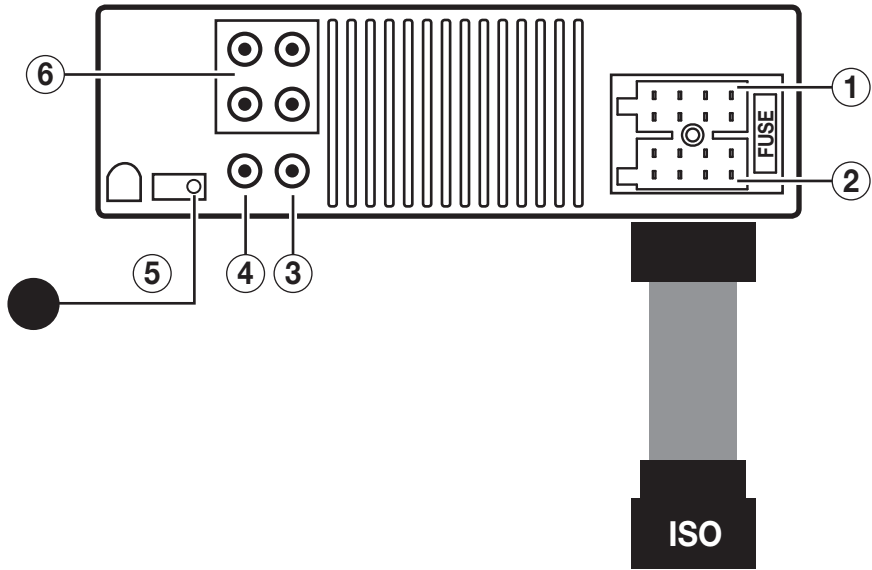

- | | |
|--------------------------|---------------------------|
| 1. Alimentation | 1. Strom-zufuhr |
| 2. Sortie hauts parleurs | 2. Lautsprechers ausgänge |
| 3. Sortie video | 3. Ausgang Video |
| 4. Sortie Sub-Woofer | 4. Ausgang Sub-Woofer |
| 5. IR Externe | 5. IR Extern |
| 6. Sortie Pre-ampl. | 6. Ausgang Pre-amp |

1 ALIMENTATION / STROM-ZUFUHR

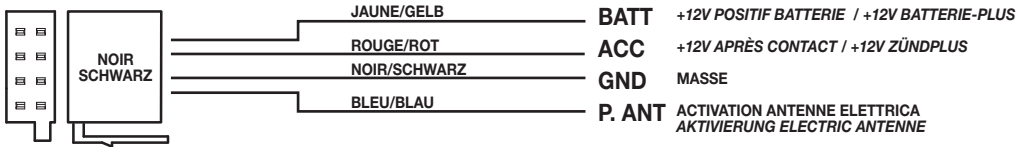

2 SORTIE HAUTS PARLEURS / LAUTSPRECHERS AUSGÄNGE

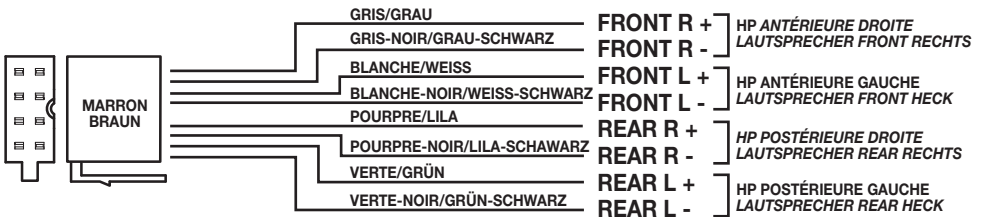

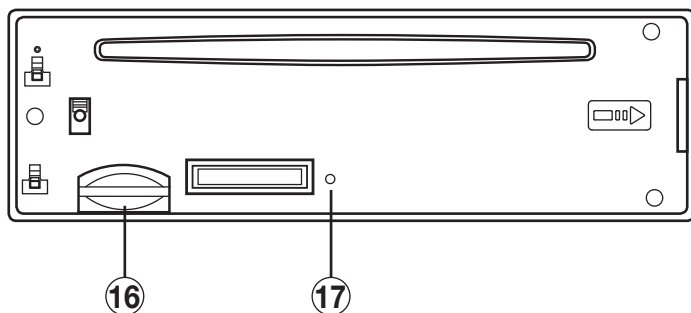

1. Expulsion du CD
2. ◀▶ Trace Précédente / Successive
3. SRC Source
4. DISCO / USB Sélection
5. Décroche la façade
6. Allumage / extinction ON / OFF
7. ▶|| Reproduction / Pause
8. RPT / RDM Répétition / Reproduction casuelle
9. Balance audio
10. Display/ Mute
11. Entrée AUX-IN
12. Port USB
13. Afficheur
14. Fente du disque
15. Réglage du volume / Menu
16. Slot SD Card
17. Touche RESET

1. CD-Auswurf
2. ◀▶ Stück davor / danach
3. SRC Quelle
4. DISCO / USB wählen
5. Bedienteil abnehmen
6. Ein-/Ausschalten ON/OFF
7. ▶|| Play/Pause
8. RPT / RDM Wiederhole / Wahllose Wiedergabe
9. Audio-Balance
10. Display/ Mute Stummschaltung (Mute)
11. AUX-IN-Eingang
12. USB-Öffnung
13. Display
14. CD-Öffnung
15. Volume / Menü Lautstärke-Regelung
16. SD-Öffnung
17. RESET-Taste

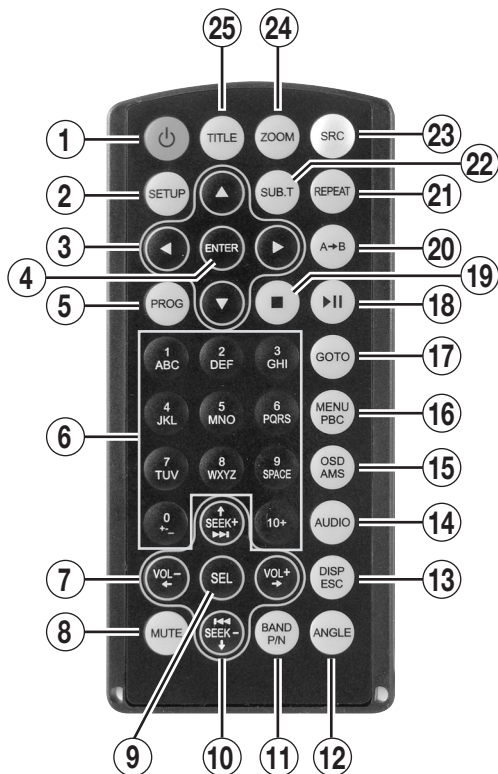

1. **POWER** Allumage / extinction
2. **SETUP**
3. ◀▶▼▲ Touches fléchées
4. **ENTER** Valide
5. **PROG** liste des programmes
6. Touches numériques
7. **VOL+ / VOL-** Réglages volume
8. **MUTE** Volume mis à zéro
9. **Pas disponible**
10. ◀◀▶▶ Trace Précédente/Successive
11. **Pas disponible**
12. **Pas disponible**
13. **Pas disponible**
14. **AUDIO** Informations audio
15. **OSD/AMS** Informations reproduction
16. **MENU PBC** Menu DVD
17. **GOTO**
18. ▶|| Reproduction/Pause
19. ■ Stop Reproduction
20. **A+B** Répétition Chapitres
21. **REPEAT**: Répétition trace
22. **SUBTITLE** Sous-titres **DVD**
23. **SRC** Sélectionne source
24. **ZOOM** Réglage
25. **Pas disponible**

1. **POWER** Einschalten/Ausschalten
2. **SETUP**
3. ◀▶▼▲ Pfeil-Tasten
4. **ENTER** = Bestätigung
5. **PROG**
6. Nummern-Tasten
7. **VOL+ / VOL-** Lautstärke-Regelung
8. **MUTE** Stummschaltung
9. **NICHT AKTIVIERT**
10. ◀◀▶▶ Stück davor / danach
11. **NICHT AKTIVIERT**
12. **NICHT AKTIVIERT**
13. **NICHT AKTIVIERT**
14. **AUDIO** Audio-Infos
15. **OSD/AMS** Wiedergabe-Infos
16. **MENU PBC** Menu DVD
17. **GOTO**
18. ▶|| Wiedergabe/ Pause
19. ■ Wiedergabe stoppen
20. **A+B** Kapitel Wiederholungen
21. **REPEAT** Stück wiederholen
22. **SUBTITLE** DVD-Untertitel
23. **SRC**: Quellen-Wahl
24. **ZOOM** Einstellung
25. **NICHT AKTIVIERT**



Appuyer la touche (SETUP) sur la télécommande
Se servir des touches ▼ / ▲ pour se placer sur la
fonction désirée et appuyer la touche ENTER pour
confirmer et SETUP pour sortir.

SET-UP-Taste auf der Fernbedienung drücken
Mit den Tasten ▼ / ▲ auf die gewünschte Funktion
gehen. Um die Wahl zu bestätigen, ENTER drücken.
Dann SETUP drücken, um Stellung wieder zu verlassen.

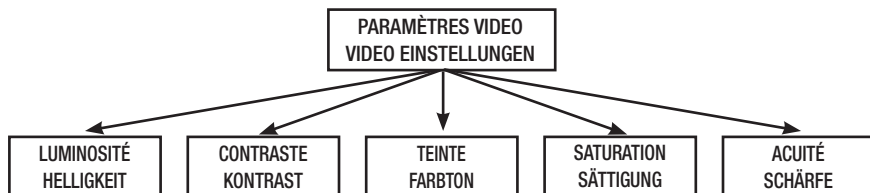
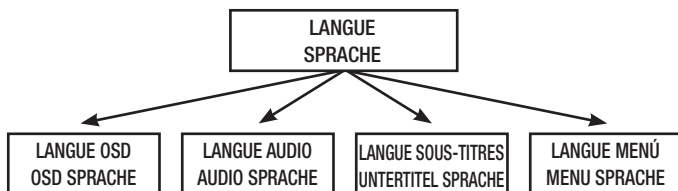
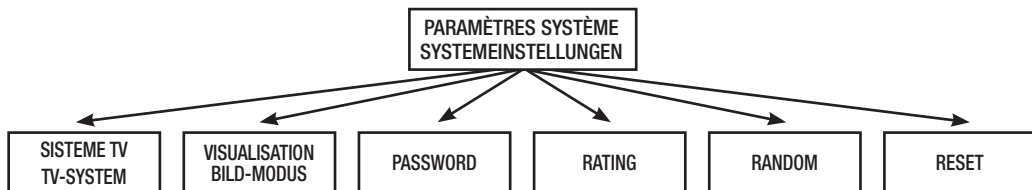

MENU DES RÉGLAGES 1

Appuyer brièvement sur le bouton, pour accéder au menu des réglages 1.

Appuyer brièvement sur le bouton, pour parcourir le menu et tourner le bouton pour modifier les paramètres.

MENÜ EINSTELLUNGEN 1

Den Knopf kurz drücken, um in das Menü der Einstellungen 1 zu gelangen.

Den Knopf kurz drücken, um das Menü zu scrollen. Dann den Knopf drehen, um die Parameter zu ändern.

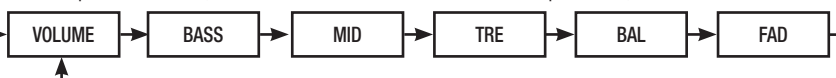

MENU DES RÉGLAGES 2

Appuyer 3 secondes sur le bouton, pour accéder au menu des réglages 2.

Appuyer brièvement sur le bouton, pour parcourir le menu et tourner le bouton pour modifier les paramètres.

MENÜ EINSTELLUNGEN 2

Den Knopf 3 Sekunden drücken, um in das Menü der Einstellungen 2 zu gelangen.

Den Knopf kurz drücken, um das Menü zu scrollen. Dann den Knopf drehen, um die Parameter zu ändern.



Sans CD dans l'appareil, introduire le support USB/SD dans l'ouverture prévue. Le Lecteur cherchera automatiquement les Fichiers présents sur le support en question.

Note: *le fonctionnement USB/SD est assuré uniquement pour la mémoire volatile (Flash).*

CD aus dem Gerät entfernen. USB/SD in die vorgesehene Öffnung eingeben. Der Player wird nun automatisch die auf USB bzw. SD eingespeicherten Dateien suchen.

Wichtig: *der USB/SD-Betrieb funktioniert nur begrenzt auf den Volatil-Speicher (Flash memory).*

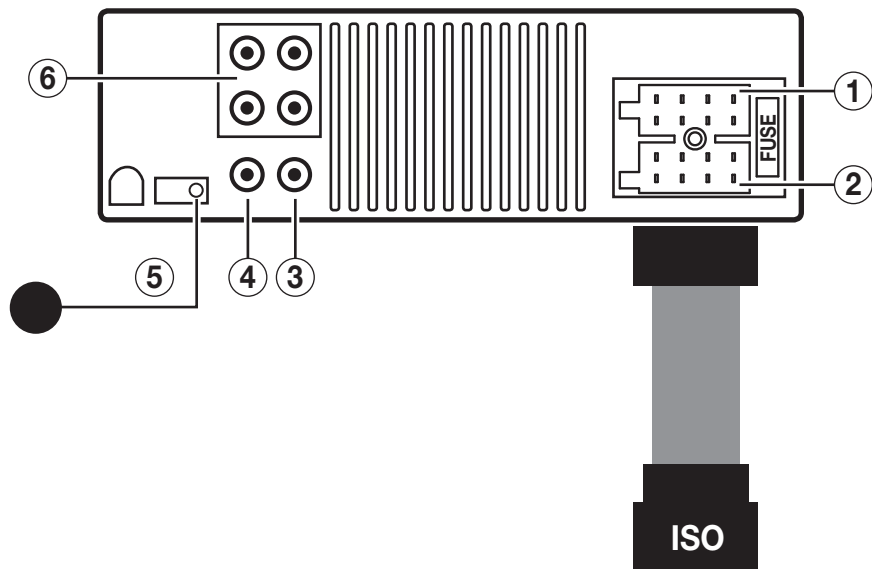

- 1. Alimentación
- 2. Salida altavoces
- 3. Salida video
- 4. Salida Sub-Woofer
- 5. IR Externo
- 6. Salida Pre-amp

1 ALIMENTACION



2 SALIDA ALTAVOCES



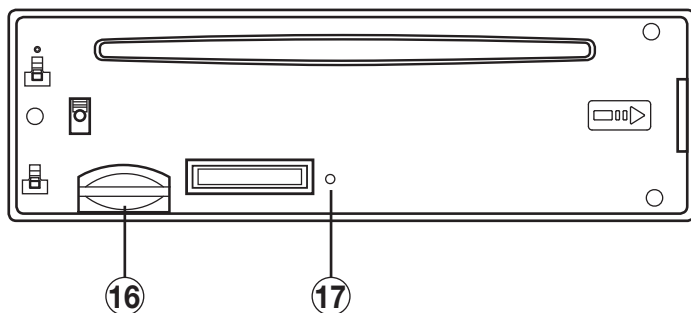

1. Expulsión disco
2. ◀▶ Pista precedente / siguiente
3. SRC Selecciona fuente
4. DISCO/USB Selección
5. Desengancha la caratula
6. Encendido /Apagado
7. ▶|| Reproducción / Pausa / Intro
8. RPT / RDM Repetición / Reproducción casual
9. Balance Audio
10. Display/ Mute
11. Entrada AUX-IN
12. Puerto USB
13. Display
14. Ranura disco
15. Volumen / Menu
16. Ranura SD Tarjeta de memoria
17. Tecla RESET

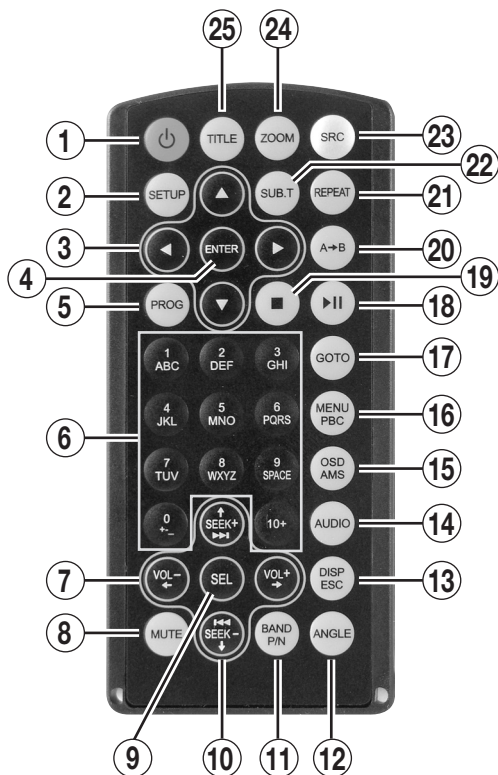

1. **POWER** Encendido/Apagado
2. **SETUP**
3. ◀▶▲ Teclas de flecha
4. **ENTER** = Confirmar
5. **PROG**
6. Teclas numéricas
7. **VOL+ / VOL-** Ajuste del volumen
8. **MUTE** Volumen 0
9. **No habil**
10. |◀◀▶▶| Pista Precedente/Siguiente
11. **No habil**
12. **No habil**
13. **No habil**
14. **AUDIO** Información audio
15. **OSD/AMS** Información reproducción
16. **MENU PBC** Menu DVD
17. **GOTO**
18. ▶|| Reproducción / Pausa
19. ■ Stop reproducción
20. **A+B** Repetición capítulos
21. **REPEAT** Repetición pistas
22. **SUBTITLE** Subtítulos **DVD**
23. **SRC** Selección fuente
24. **ZOOM** Ajuste
25. **No habil**

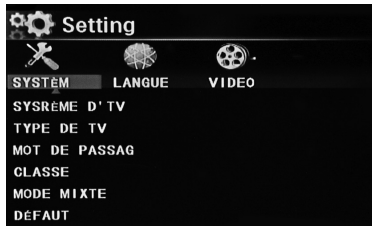

Presionar la tecla (SETUP) en el mando a distancia.
Utilizar las teclas ▼ / ▲ para posicionarse en la función deseada y presionar la tecla ENTER para confirmar SETUP para salir.

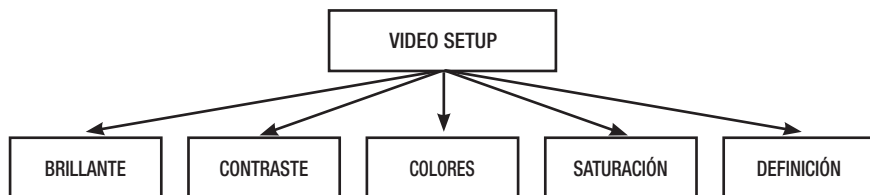
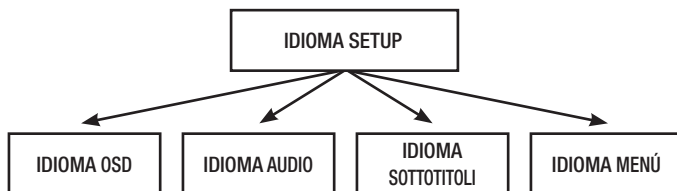
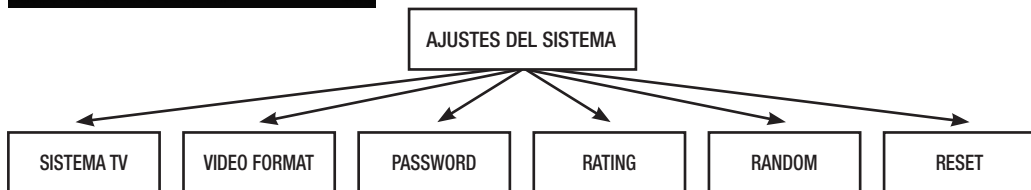

MENÚ AJUSTES 1

Pulsar brevemente el mando del volumen para acceder al menú de ajustes 1.

Pulsar brevemente el mando para ver las funciones y girar el mismo para modificar los valores.

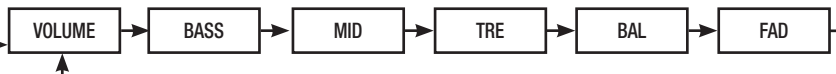

MENÚ AJUSTES 2

Pulsar durante 3 segundos el mando para acceder al menú de ajustes 2.

Pulsar brevemente el mando para ver las funciones y girar el mismo para modificar los valores.



USB-SD card

En ausencia del disco, introducir el dispositivo USB/SD en el específico puerto o correspondiente ranura. El reproductor buscará automáticamente los archivos presentes en el soporte.

Nota: el funcionamiento USB/SD es válido solo para la memoria volátil (flash). Los formatos compatibles son: MP3, WMA, MPEG-4.

Caratteristiche tecniche • Technical specifications
Caracteristiques techniques • Technische daten
Caracteristicas tecnicas

- **Sistema colore / Colour System** NTSC/PAL
- **Formati visualizzazione / Conforming format to** 16:9 – 4:3 letter box
- **Visualizzazione DVD multiangolo / Multi angle DVD vision**
- **Menù, sottotitoli e audio multilingua / Multilanguage Menu, subtitles and audio**
- **Memorizzazione ultima posizione / Last position memory**
- **Equalizzatore 4 bande / 4-band Equalizer** (Classic, pop, rock, flat)
- **6 Velocità di scansione / 6 scan speeds**
- **Meccanica anti-urto / Anti shock housing**
- **Protezione elettronica contro gli urti / Electronic shock protection system**
- **1 Porta USB anteriore / 1 USB Front input**
- **1 Slot SD/MMC card / 1 Front SD/MMC card slot**
- **1 Ingresso aux-in anteriore / 1 Front aux-in input**
- **Potenza 4x40W MAX/ 4x40W MAX high power amplifier**
- **1 Uscita audio stereo 2 Volt / 1 Stereo audio output 2 Volt**
- **1 Uscita video / 1 Video output**
- **Ricevitore IR / IR Sensor**
- **Telecomando con tutte le funzioni / Remote Control with full Functions range**
- **Alimentazione / Power** 12 V



ISO



10R - 053672