



YOUR MUSIC. **YOUR POWER.**

EVO<sup>4.0</sup>

**OWNERS MANUAL**

**800.4 EVO<sup>4.0</sup>**

Introduction.....	3
Package contents.....	3
Safety instructions.....	4
Montagem e desmontagem da capa plástica.....	5
Panels description	
Audio inputs and controls.....	6
Power inputs and audio outputs.....	7
Electrical Dimensioning.....	8
Audio inputs.....	8
Installation sequence.....	9
Wiring diagram	
Four channels wiring diagram.....	10
Three channels wiring diagram.....	10
Two channels wiring diagram.....	11
Procedure for setting the gain.....	11
Crossovers set up.....	12
Technical specs	
Parameters.....	13
Dimensional data.....	13

**Dear Customer,**

Congratulations on acquiring your Soundigital! You've just purchased a product of high quality and technology. The Soundigital products are developed to assure maximum efficiency and reliability to your sound system.

**Class D amplifiers:**

The main characteristics of Class D amplifiers are audio quality, efficiency, versatility and compact design. Here are the advantages of these characteristics:

**Audio Quality** – Class D amplifiers used to have a limited response in the past and they used to have a worse performance regarding higher frequencies than Class AB amps, despite being more efficient. Introducing new technologies, Soundigital developed a Class D amplifier superior to the Class AB ones in efficiency and performance.

**Efficiency** - The Soundigital Class D amplifiers have a total efficiency (power source + output) higher than 70%, assuring a battery consumption and a heating lower than the expected.

**Versatility of uses** –The flat response of all the frequencies of Soundigital amplifiers allows them to be used in all the kinds of systems: SPL, Sound Quality, Trio Eletrico and Pancadao, meeting the needs with extreme quality.

**Compact design** – The high efficiency and technology allow our amplifiers to be really compact, making it easy to install them in vehicles where you have limited space.

**IMPORTANT INFO**

Read this manual and follow its instructions and information carefully. It contains extremely important information to have your amplifier working properly. If you feel the need to contact our Tech Support, you can reach our technician through the e-mail [info@soundigitalusa.com](mailto:info@soundigitalusa.com).

**PACKAGE CONTENTS**

- 1 **EVO4.0** Amplifier
- 1 Installation quick guide with warranty card
- 1 Promotional sticker

To prevent injuries to the user or damage to the amplifier, read all safety instructions written on this manual;

If you are insecure about the installation of this equipment, get in touch with our tech support or with a professional specialized in car audio installation;

Before proceeding with the installation of any electric equipment on your vehicle, unplug the negative (-) terminal of the battery to avoid fires, injuries or damages;

Use your sound system safely. The continuous exposure to sound pressures over 85dB may cause irreversible hearing damage;

This equipment is for use in automotive DC voltage batteries between 12.6 and 14.4 volts. Before installing the equipment, check voltage of the batteries;

Do not install the amplifier in places exposed to water, dirt or humidity;

Choose a ventilated place to install the amplifier and avoid blocking the side ventilation windows;

Mount the amplifier in a secure way. Avoid mounting it on metallic parts of the vehicle, because it may cause ground looping (noise);

Make sure that the location chosen for the amplifier installation does not effect the operation of the vehicle;

When passing cables through metallic walls, use rubber O-rings to avoid cable cutting and short-circuits.

Clean the amplifier periodically with brush or dry cloth to assure the thermal efficiency of the heatsink.

This product may reach temperatures over 60°C/140°F. Make sure it is cold before touching it;

Be careful when making holes in the vehicle. Make sure you are not making holes in the fuel tank, brake lines or electrical cables of the vehicle

Make sure the cables are properly secured throughout the installation;

Wear gloves, safety glasses and and all necessary PPE during the installation of SounDigital amplifiers.



**Warning!**

THIS "WARNING" SIGN ALERTS THE USER OF IMPORTANT INFO. NOT FOLLOWING THIS INSTRUCTIONS MAY CAUSE INJURIES TO THE USER OR DAMAGE TO THE EQUIPMENT.

The plastic covers have the function of finishing and hiding the amplifier fixing screws. To disassembling and assembling them, follow the instructions below.

### DISASSEMBLING OF THE PLASTIC COVER

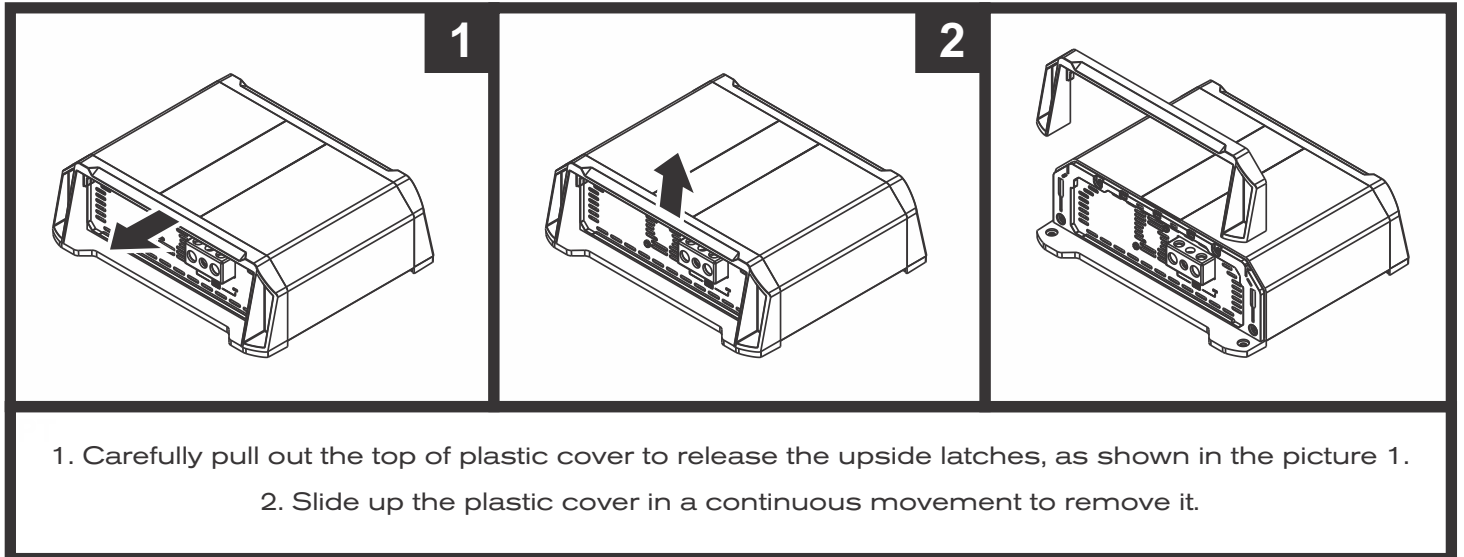

### ASSEMBLING THE PLASTIC COVER

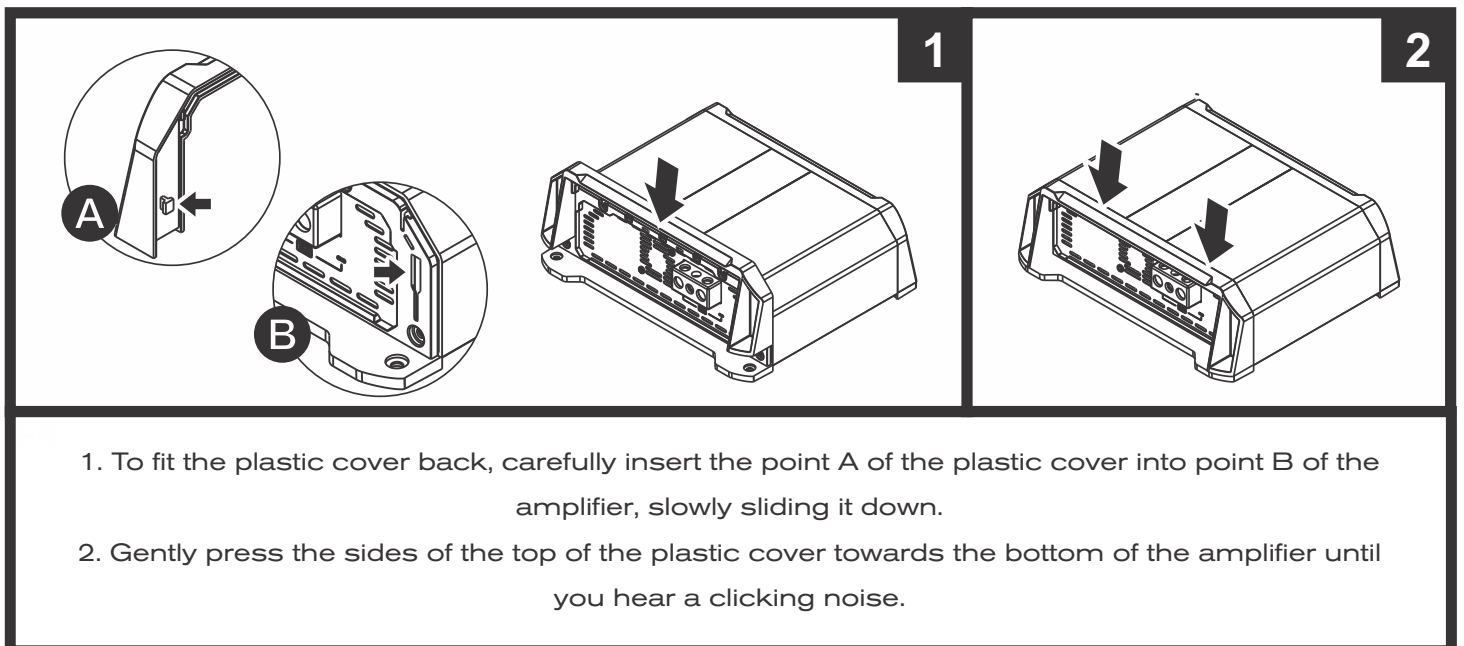

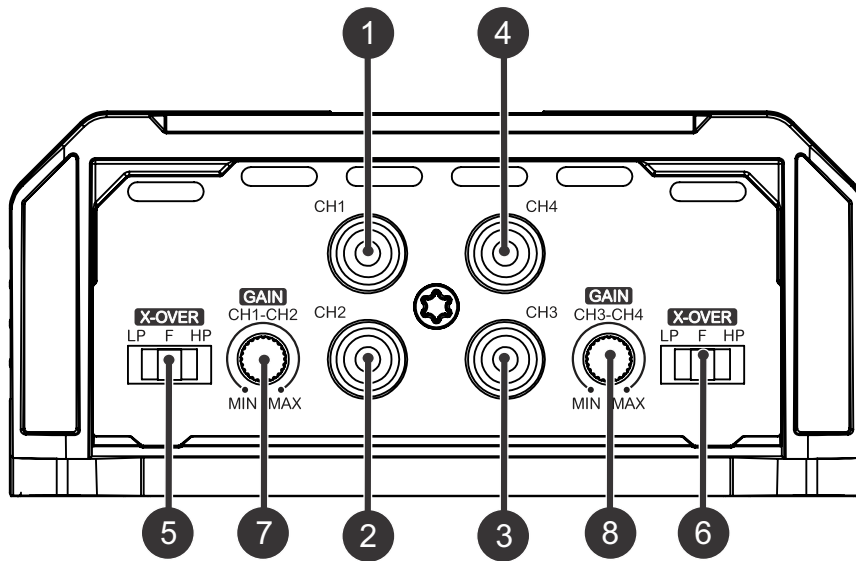

1	CH1	
2	CH2	
3	CH3	Audio input - RCA connector
4	CH4	
5	CH1/CH2	Crossover Switch Low Pass - Full - High Pass
6	CH3/CH4	
7	CH1/CH2	Variable Gain Control
8	CH3/CH4	

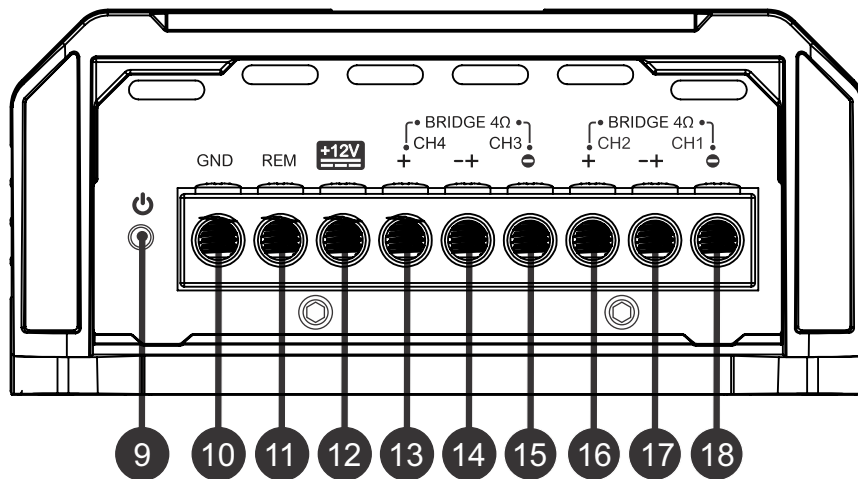

9	-	"Power on" LED indicator (Blue)
10	-	Negative power supply connector (GND)
11	-	Remote power supply connector (REM)
12	-	Positive power supply connector (+12v)
13	CH4	Positive audio output connector
14	CH4/CH3	Shared connector between channels 4 (-) and 3 (+)
15	CH3	Negative speaker connector
16	CH2	Positive speaker connector
17	CH2/CH1	Shared connector between channels 2 (-) and 1 (+)
18	CH1	Negative speaker connector

## ELECTRICAL DIMENSIONING

For proper operation of your SounDigital amplifier, you need the proper dimensioning of the electrical system and the cables used.

The table below shows the minimum section of GND cables, +12VDC cables and speaker output cables according to the power generated by the amplifier.

800 WRMS	POWER CABLE	10mm <sup>2</sup> - 7 AWG
	GROUND CABLE	
	SPEAKER CABLE	2 x 1.5mm <sup>2</sup> - 15 AWG

We recommend the use of ONLY OFC (Oxygen Free Copper) Cables on the installation of our products.

## AUDIO INPUTS

### RCA Inputs

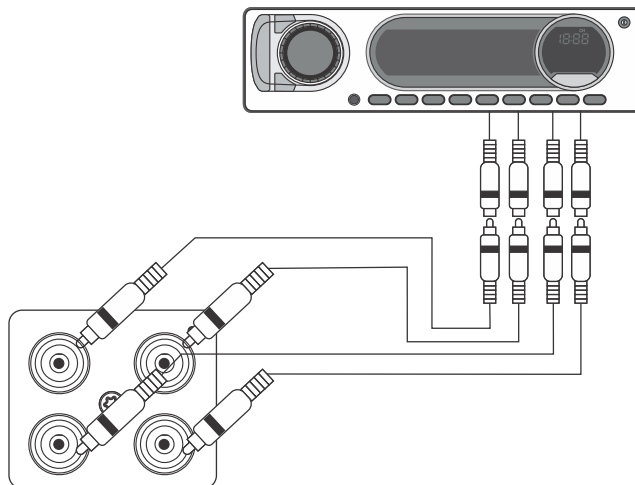

All RCA Inputs must be connected for the 4 channels to work.



**Warning!**

BEFORE PROCEEDING WITH THE INSTALLATION, UNPLUG THE NEGATIVE TERMINAL FROM ALL OF THE BATTERIES, TO AVOID FIRE, DAMAGE TO THE AMPLIFIER AND THE USER HIMSELF.

- Mount the amplifier in such a way you have access to the connectors;
- Install the power cables in the vehicle properly, starting from the battery to the fuse holder or circuit breaker, use the cable with the appropriate size. Make all connections, install fuse holders or circuit breakers, but without placing the fuses or with the circuit breakers in the "Off" position.

**Warning!**

THE MAX. DISTANCE FOR THE INSTALLATION OF THE FUSE/CIRCUIT BREAKER IS ONE FOOT (30 CM) AWAY FROM THE BATTERY.

- Connect the power cables in to the amplifier, observing the polarity. Connect all the positive cables from the fuse holder or circuit breaker to the positive connector of the amplifier and all the negative power cables from the batteries to the negative connector of the amplifier;
- The ground cable must be as short as possible and must be connected to the vehicle chassis and the battery negative;

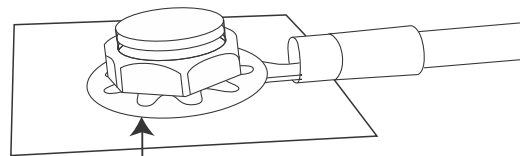

Remove the paint between the terminal and chassis

- Install the signal input cables in a proper way, distant from the power cables;
- Connect the RCA or the high signal input cables to the head unit and amplifiers;
- Install the audio output cables with the appropriate section, distant from the power and audio input cables;
- Connect the audio output cables to the amplifier and speakers respecting the positive (+) and negative (-) polarities;
- Install the remote cable with the power cables, using 1.5mm<sup>2</sup> (15 AWG) cable or thicker;
- Connect the remote power cable to the amplifier's "REM" terminal at the main unit's remote power output (when not using the high level signal inputs);
- Before powering the system, verify all the connections and make sure there are no mistakes or short-circuits on the power and ground cables;
- Reconnect the ground of the batteries;
- Check if the headunit is turned off and then place the fuses in the fuse holders or switch the circuit breakers on;
- Turn on the main unit and the amplifier will turn on the "On" LED indicating that it is in operation.

#### 4 CHANNEL WIRING DIAGRAM

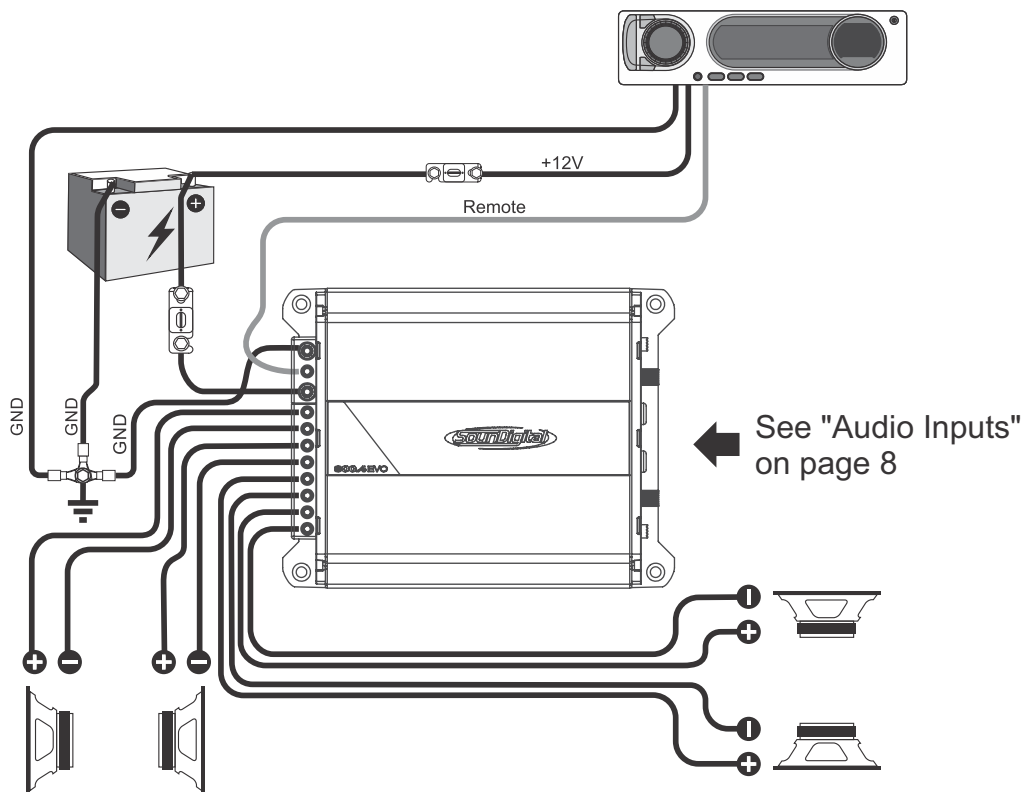

#### 3 CHANNEL WIRING DIAGRAM

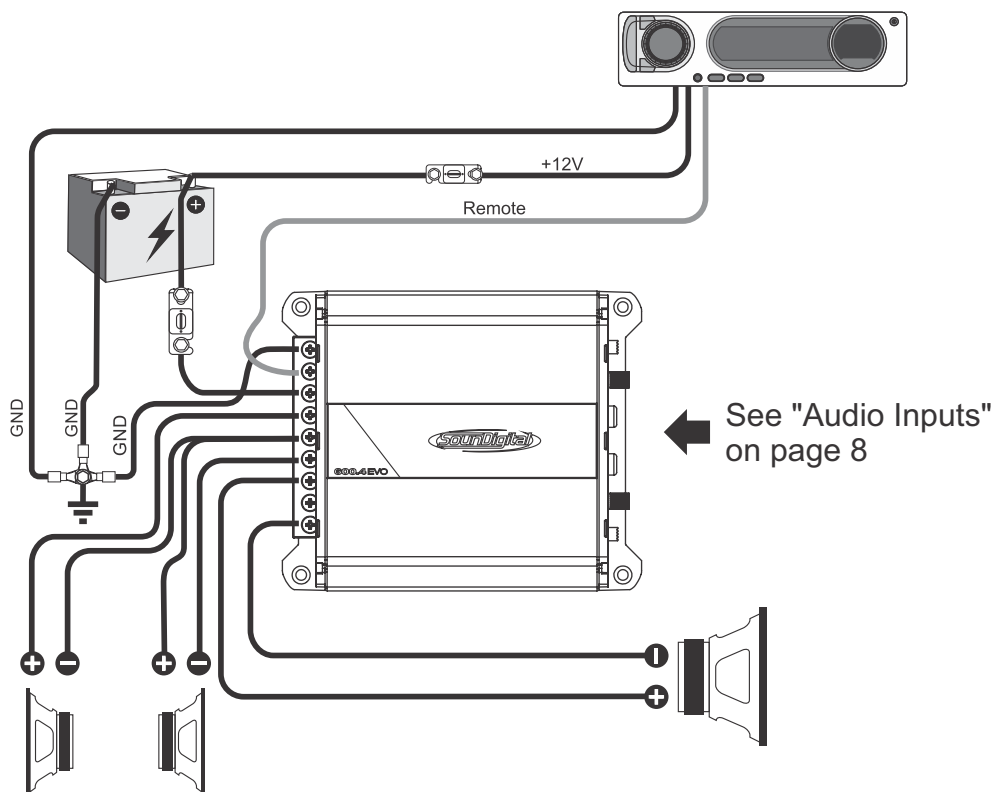

## 2 CHANNEL WIRING DIAGRAM

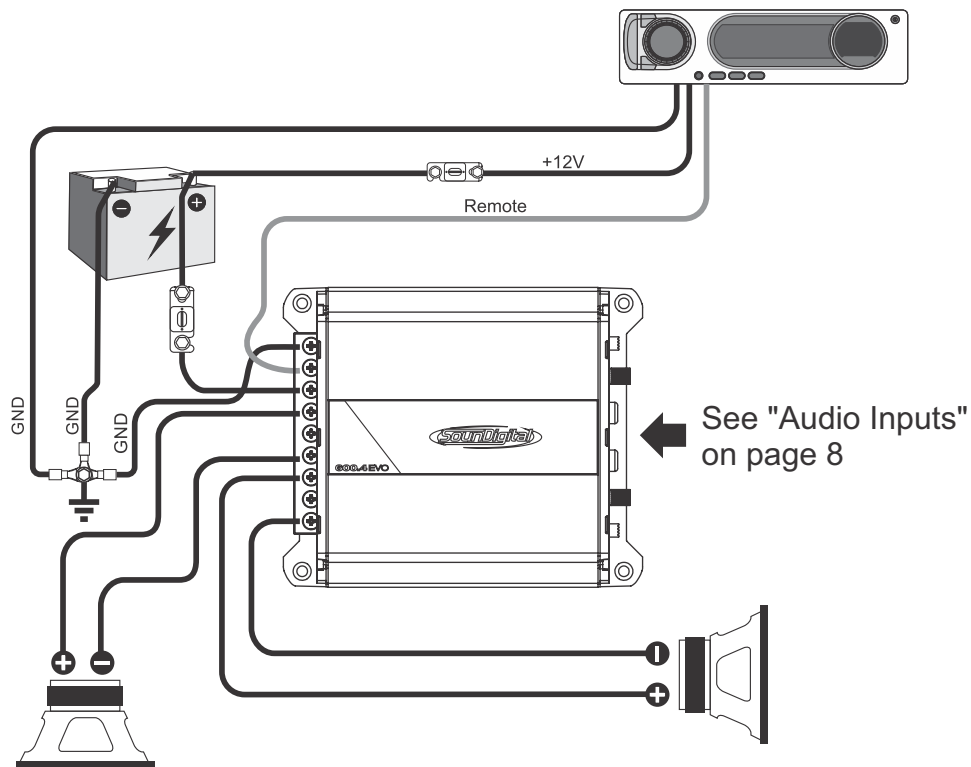

### GAIN SETTING

Necessary equipment:

- Digital AC voltmeter;
- Media with sine wave test tone 60Hz recorded at 0db;
- Screwdriver 1/8" (for gain set)

### Set up procedure

- This procedure is the same for both gain controls;
- Turn the gain control all the way down.
- Disconnect the output cables from the amplifier outputs;
- Turn off all processing (bass, treble, loudness, EQ, etc.);
- Set the source unit volume to 3/4 of full volume.

- Set the source unit's fader control to center position;
- Set the crossover selector switch in "F"
- Use a 60 Hz sine wave
- Connect the AC voltmeter to the speaker output connectors of the amplifier. Make sure you test the voltage at the correct connectors (+ and -);
- Increase the gain control until the target voltage is observed with the voltmeter (see the chart below);
- Once you have adjusted the amplifier to its correct voltage output, turn off the source unit and reconnect the speaker(s)

Download the tracks for set up in <https://sounddigitalusa.com/tracks-for-set-up/>

MODEL	STEREO / POWER	BRIDGE / POWER	STEREO OUTPUT VOLTAGE	BRIDGE OUTPUT VOLTAGE
600.4 EVO <small>4.0</small>	2Ω / 150W	4Ω / 300W	17.4 V	34,7 V

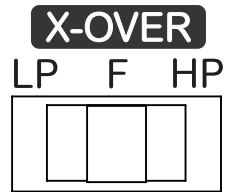

"F" All the frequencies are reproduced;

"LP " Frequencies below 80Hz will be reproduced;

"HP " Frequencies above 80Hz will be reproduced.

- Switch Key to "F" position (Full Range): All the frequencies are reproduced.

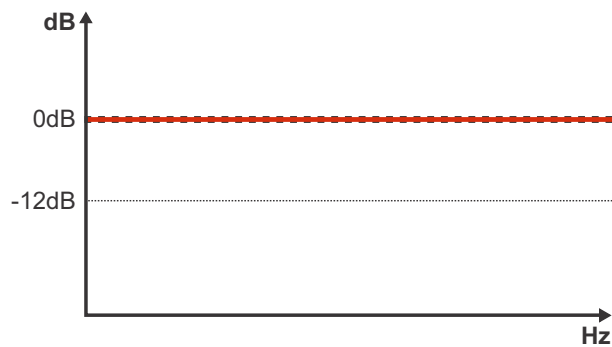

- Switch Key to "HP" position (High Pass): Frequencies above 80Hz will be reproduced;

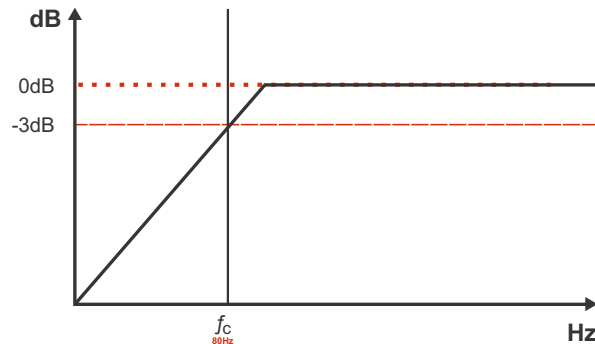

- Switch Key to "LP" position (Low Pass): Frequencies below 80Hz will be reproduced;

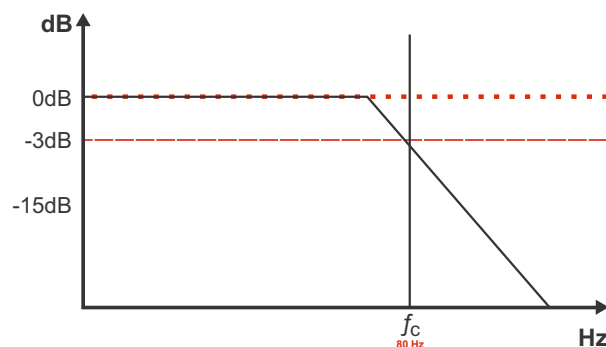

PARAMETERS	800.4 EVO <sup>v1.0</sup>
Power RMS Bridge @ 8Ω*	2 X 264W
Power RMS Bridge @ 4Ω*	2 X 400W
Power RMS @ 4Ω*	4 X 132W
Power RMS @ 2Ω*	4 X 200W
Frequency Response (-3db)	10Hz ~ 20kHz
Low Pass filter (12dB/oct)	80Hz
High Pass filter (12Db/oct)	80Hz
Operating Voltage	8V ~ 16V
SNR	88dB
Input Sensitivity	0.2 ~ 4V
Current Draw (Music)	40A
Current Draw (Max)	80A
Total Efficiency	79%
Damping Factor (@100Hz nominal impedance)	200
Stereo Minimum Impedance	2Ω
Bridge Minimum Impedance	4Ω
Fuse (music)	40A
Recommended battery	60Ah

\*Power at 12.6V @ 60Hz with a maximum THD of 1%.

## DIMENSIONAL DATA

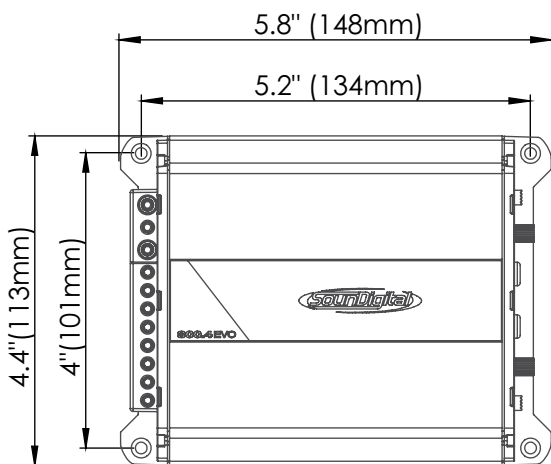

Net Weight: 1.54lb (0.70 kg)  
Gross Weight: 1.70lb (0.77 kg)





YOUR MUSIC. **YOUR POWER.**



Consumer  
Technology  
Association™



[WWW.SOUNDIGITALUSA.COM](http://WWW.SOUNDIGITALUSA.COM)



[SOUNDIGITALUSA](https://www.facebook.com/SOUNDIGITALUSA)



[SOUNDIGITALUSA](https://www.instagram.com/SOUNDIGITALUSA)