

This power amplifier is featured with a efficient protection system to prevent any damages like overheating, overvoltage and short-circuit. In order to check the problem, first turn down all levels of the head unit, afterwards turn it off.

AMPLIFIER IS NOT POWERED UP, NO LED IS LIGHTENING	<ul style="list-style-type: none"> - ground connection professional connected? - +12V powercable professional connected? - remote cable professional connected? - fuses inserted and alright? - analyze voltage on the amplifier. - signal is presented?
NO SOUND	<ul style="list-style-type: none"> - cinch cable alright and professional connected? - loudspeaker professional connected? - head unit alright? - signal is presented?
OVERHEATING	<ul style="list-style-type: none"> - impedance alright? - loudspeaker error? - adequate airflow of the amplifier? <p>! CAUTION ! After cooling down, the amplifier turns on automatically.</p>
ERROR IN AMPLIFIER FUSE	<ul style="list-style-type: none"> - ground professional connected? - loudspeaker impedance alright? <p>! CAUTION ! Make sure when changing fuses to use the same value.</p>
SOUND TOO LOW OR LOW-DISTORTED SOUND	<ul style="list-style-type: none"> - input level control "GAIN" is set to match the head unit? - output level control of the head unit alright? - loudspeaker error? - loudspeaker cable checked? - crossover frequencies has been properly set? (Check head unit, amplifier, DSP, sound processor, equalizer, frequency bandpassfilter...)
HIGH HISS-ENGINE NOISE IN SPEAKERS	<ul style="list-style-type: none"> - ground connection professional connected? - short-circuit caused by loudspeaker cable with vehicle chassi (ground)? - cinchcable (RCA) and/or loudspeaker cabel installed too close to the power connection cable? - cinch ground (RCA) of the head unit alright?

⚠ CAUTION ⚠

Please contact your specialist dealer if the amplifier is still not working after it has been checked with the error list!

For warranty adjustment / repairs the original invoice has to be attached!

Opening the power amplifier is leading to a lost of warranty in either case!

MANUAL
CO-40.4

DESIGNED AND ENGINEERED BY AUDIO SYSTEM GERMANY



Congratulation on your purchase of your new **C-SERIES** amlifier.

IMPORTANT: Before installation your power amplifier, we recommend to read the owner's manual carefully and to follow the instructions regarding connection and fitting exactly.

ATTENTION: Pay attention to advices and instructions of the car manufacturer.

IMPORTANT: Your proof of purchase is evidence of warranty claim for repair or replacement. Keep your proof of purchase, manual and original packaging.

ATTENTION: Use of sound components can impair your ability to hear necessary traffic sounds and may constitute a hazard while driving your automobile.

AUDIO SYSTEMGERMANY accepts no liability for hearing loss, bodily injury or property damage as a result of use or misuse of our products.

We recommend installing the equipment by an authorized service center or dealer. A professional fitting and connection is the requirement for further warranty and perfect sound.



FEATURES

- 4-Channel-Mini-Amplifier
- Stable into 2 Ohm Stereo per channel
- Extreme high input sensitivity from 0,1 to 13 V
- **Multi-Way Protection Circuitry:** overheat, over load and short circuitry protection
- Full-Active-Mode possible
- High level input (via RCA input) with automatic activation of the power amplifier
- AUX input with automatic switch-on or cinch input



SPECIFICATIONS

Power Supply Voltage	10 - 16 V
Rated Power Output at 14,4 V	
- RMS power @ 4 ohm stereo	4x 40 W
- RMS power @ 2 ohm stereo	4x 60 W
Signal to Noise Ratio	> 88 dB
Low Pass Filter (LPF) Channel 3+4	80 oder 1500 Hz
High Pass Filter (HPF) Channel 1+2	80 bis 4000 Hz
Frequency Response	35 Hz ~ 20 KHz (+/-1 dB)
THD@RMS Watts at 4 Ohm and 1/2 rated power	< 0,03%
Channel Separation	65 dB
Fuse Rating	1x 15A
Input Sensitivity	100 mV ~ 13 V (+/- 5%)
Dimensions	123(L) x 45(H) x 80(W) mm



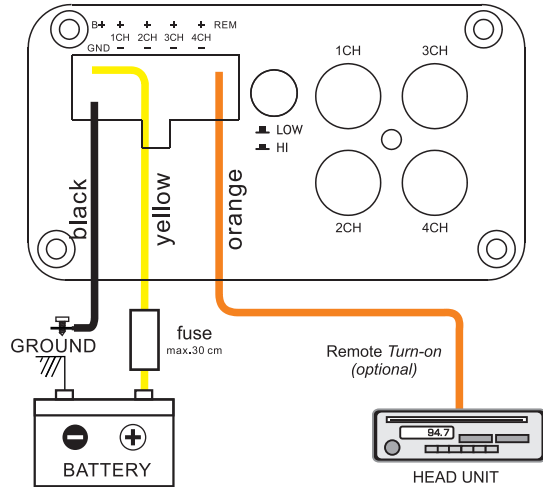

1. Battery disconnection

First disconnect the power supply of the vehicle. This works out the best by removing the ground cable of the battery.

2. Ground connection

Connect the GND (ground) connection of the amplifier with the car chassis. Keep this cable as short as possible (not longer than 50 cm) and use a suitable cross section (AWG size 6 - 10). Make sure, that the connection with the vehicle chassis is free of paint, dirt and dust.

3. +12 V Power connection: Connect the +12 V contact of the amplifier with the supply cable via a fuse directly to the vehicle battery. Keep in mind, that the length of the cable from fuseholder to vehicle battery has to be a maximum of 30 cm. Requirement for a perfect function of the amplifier is a qualitative high end fuse holder as well as a suitable cable cross section (AWG size 6 - 10). This fuse protects the amplifier and the vehicle against the possibility of a short circuit in the power cable.

4. Remote connection (optional): You can optional connect the REM-terminal of the amplifier to the remote-output (automatic 12 V antenna-output) of the head unit. Therefore use a 0,5 - 1,5 mm power cable.

5. High Level Input: If the radio (normally original radio, OEM) has no RCA output and remote output (automatic 12 V antenna output) it is possible to connect the speaker output from headunit direct in „High Level Input“. If the amplifier get a signal from head unit output, the amplifier will turn on.

Caution

Please take the following precautions when installing your amplifier:

- a) Take extra care when making the connections. Make sure that no electrical cable, gas tank, hydraulic brakes or other components get damaged.
- b) Allow enough cooling and air circulation and avoid installing the unit in small closed boxes or close to parts that heat up easily.
- c) Keep the amplifier away from liquid, moisture, heat and foreign materials.
- d) This amplifier can only be used in vehicles with 12V DC power supply.
- e) Never install the power supply cable with other original vehicle wires (gas cables), fan motors, control modules etc.
- f) Install the signal cable (cinch cable) as well as speaker cable far away from the power cables to avoid interference with music signals.
- g) To avoid dangers of cables binding, squeezing or breaking, use the cables supplied with your amplifier.

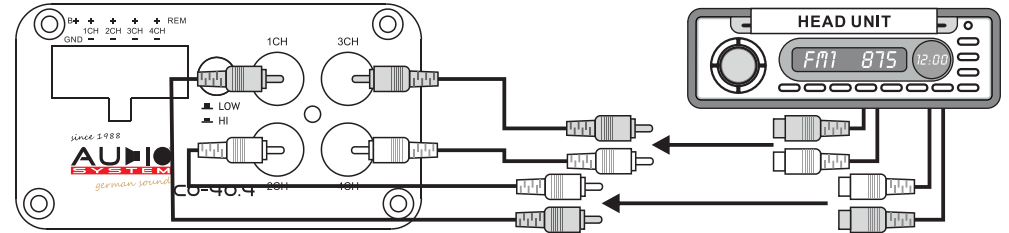

The CO-40.4 offers RCA and AUX-Inputs, which are connected through cinch cables with the preamplifier-outputs of the head unit (head unit, MP3-Player, iPhone, iPad). If there is a signal at the AUX input, the power amplifier switches on automatically. **Priority 1 is always the AUX input. This means that if there is a signal at the AUX input, it is always switched to the AUX input.** If signal is presented at RCA, AUX or High Input, the amplifier automatically turns on and the power LED lights. With the aid of the gain-controller and variable crossover you are able to adjust the amplifier on to your preferred taste of hearing, the circumstances of the vehicle and to the speakers.

In this regard, **AUDIO SYSTEM GERMANY** recommends to adjust your amplifier through a specialized service center, dealer or a specialist.

Full-Range Stereo

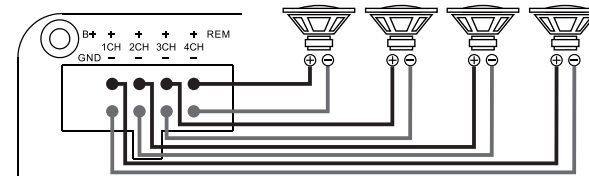

Speaker Impedance 2 ~ 4 Ohm

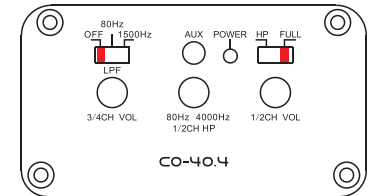

Subwoofer + Front System

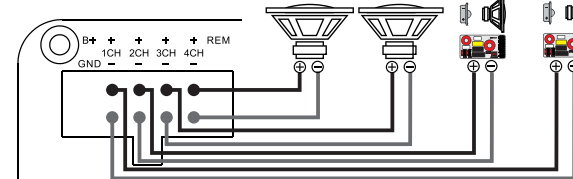

Speaker Impedance 2 ~ 4 Ohm

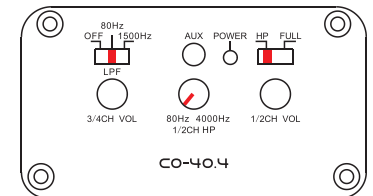

Full-Active-Mode

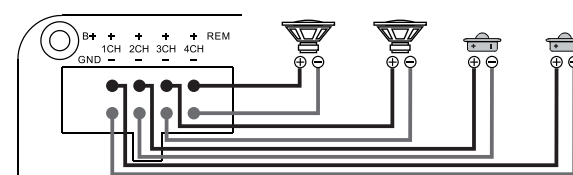

Speaker Impedance 2 ~ 4 Ohm

