

Double DIN Installation Manual

• Opel Zafira Tourer (P-J/SW/V) 01/2012 ->

colour / part-no.:
jet black
brown

Compatible with these double DIN devices

Double DIN Navigation

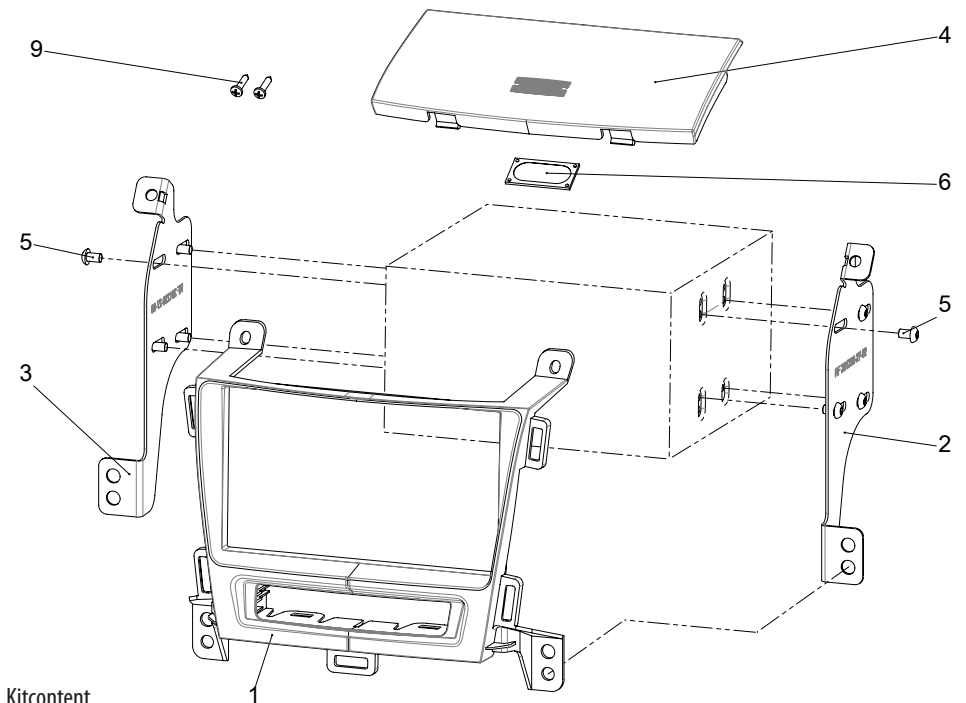

Kitcontent

(1) Facia Plate

(2) Mounting bracket right

(3) Mounting bracket left

(4) Blanking cover

(5) Flat headed screw

(6) Speaker

(9) self-tapping convex fillister head screw



1. Unclip and remove top panel



2. Remove 4 screws

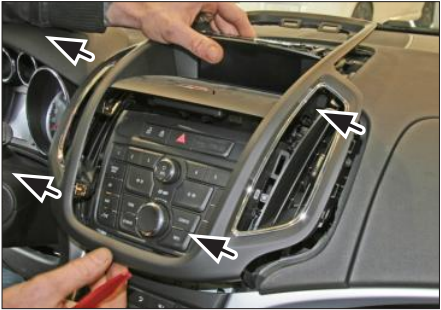

3. Unclip and remove center panel



4. Unclip and remove left decor panel



14. Fix all required circuit points

Fix double DIN head unit on dash board

Reinstall everything in reverse order to finish installation

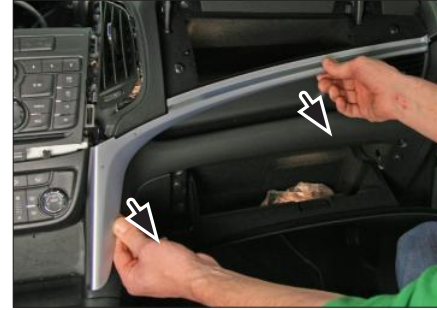

5. Unclip and remove right panel

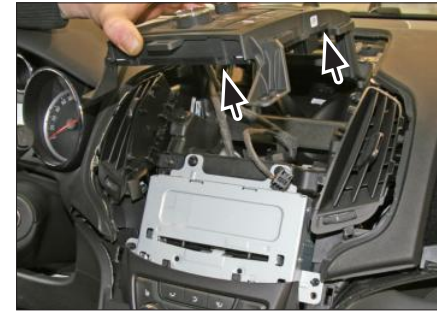

6. Remove screws of OEM head unit control unit

Remove OEM head unit control unit



7. Remove screws of air condition control unit

Remove air condition control unit



8. Remove screws of OEM head unit

Remove OEM head unit

9. Drill two holes (1,5 - 2mm) beside OEM airvent screws (see arrows and „x“)
Use 2 self-tapping convex fillister head screws to secure the air vents

Remove OEM screws of air vents. Cut away plastic in order to clear space for Double-DIN navigation (see white line)

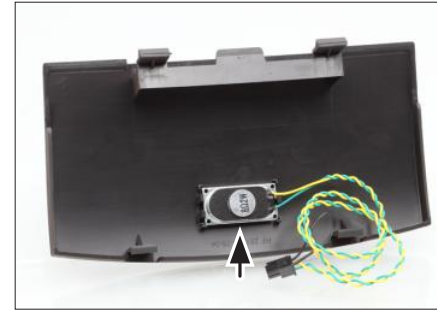
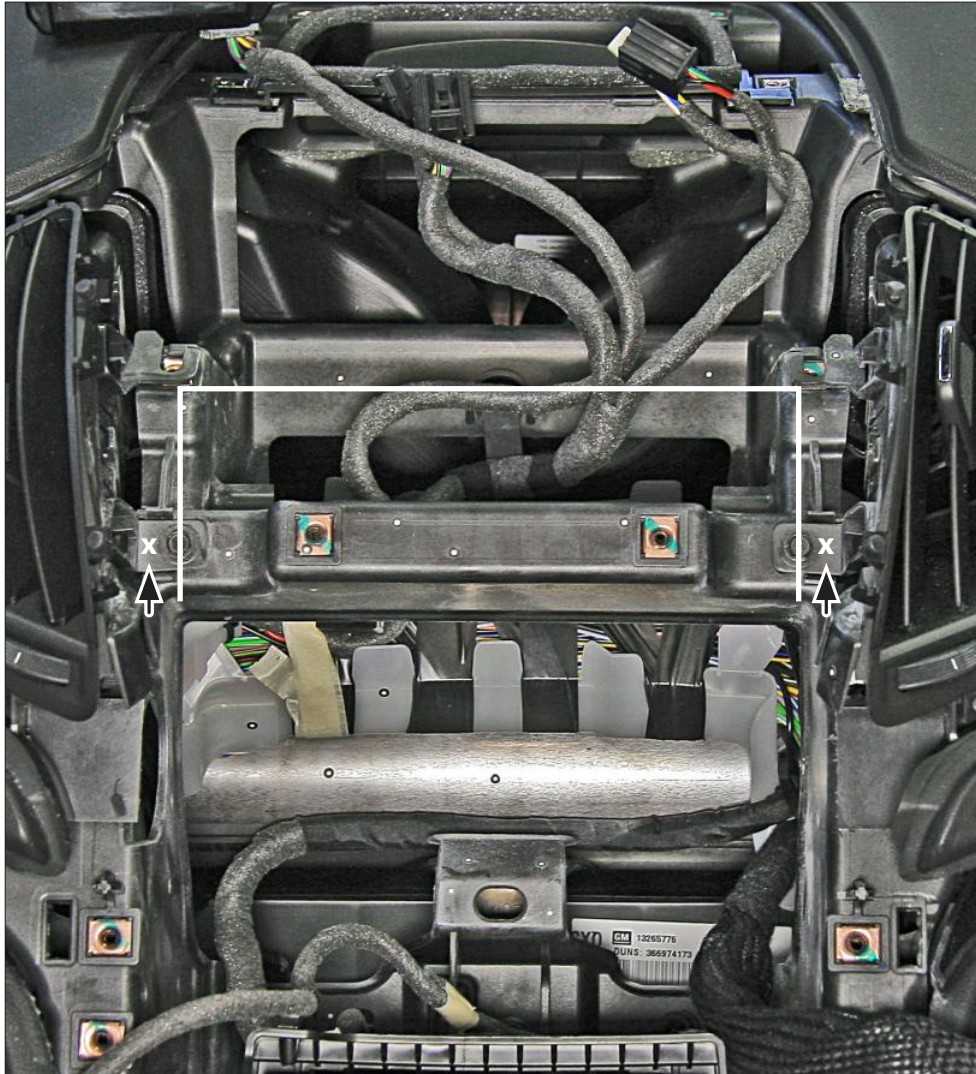

10. Clip speaker into rear side of blanking cover (see arrow) until it snaps in

We recommend to use glue in order to fix

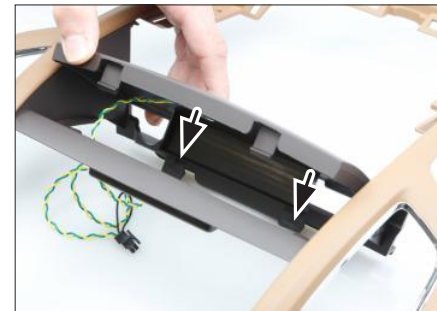

11. Clip rear side of blanking cover into OEM panel

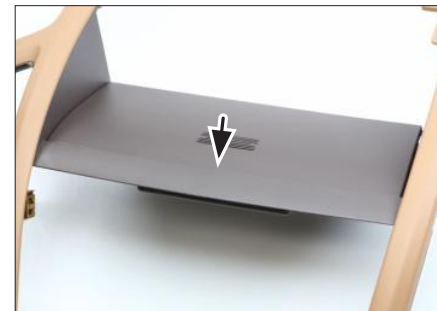

12. Clip front side of blanking cover into OEM panel

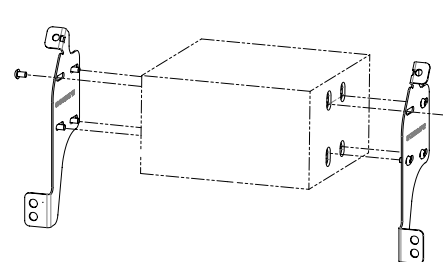

13. Mount mounting frames to double DIN head unit

*All installation work must be performed by a qualified professional installer only.
The manufacturer / dealer is not liable for any kind of incidental or indirect damages.*