



05959

INTERFACCIA VIDEO HDMI
HDMI VIDEO INTERFACE
PLUG&PLAY



MERCEDES

NTG 4.5 system with 5.8" or 6.5" Display

A Class (W176) 2012>, GLA Class (X156) 2014>,
CLA Class (C117) 2014>, B Class (W246) 2012>,
C Class (W204) 2011-2014, E Class (W212) 2012-2016,
ML/GL Class (W166/X166) 2011>

Istruzioni di montaggio **IT**

Installation instructions **EN**

Instructions de montage **FR**

Montageanleitung **DE**

Instrucciones para el montaje **ES**



IT

L'interfaccia Phonocar 05959 consente l'ingresso HDMI e telecamera sullo schermo OEM. Grazie a questa mini interfaccia plug&play è possibile utilizzare il tuo dispositivo Apple o Android sfruttando la funzione mirror del display del tuo smartphone direttamente sullo schermo originale. Ingressi per telecamera anteriore e posteriore aftermarket di serie.

APPLICAZIONE

Per veicoli MERCEDES con NTG 4.5, schermo 5,8"e 6,5".

INCLUSI NEL KIT :

Interfaccia Phonocar 05959, cablaggio auto.

PRIMA DELL'INSTALLAZIONE

Leggere con attenzione il manuale prima dell'installazione. E' necessario essere in possesso di conoscenze tecniche per procedere all'installazione. Il luogo di installazione deve essere privo di umidità e al riparo da fonti di calore, il produttore è sollevato da ogni responsabilità circa l'installazione del prodotto.

SUPPORTO

Nell'intento di fornire al cliente soluzioni rapide e adeguate in caso di problemi tecnici, si prega di fornire il maggior numero di informazioni possibili, in caso di richiesta di supporto.

Per maggiori informazioni: phonocar.com

EN

The interface 05959 allows HDMI & Camera input to the OEM screen.

This plug and play Mini interface adds HDMI to connect your Apple or Android device, allowing you to mirror your smartphone display on the vehicle's original screen. Inputs for front and rear aftermarket cameras also come as standard with the Mini.

APPLICATION

For MERCEDES vehicles with NTG 4.5 with 5.8" e 6.5" display.

KIT INCLUDES

Phonocar 05959 Interface, vehicle Harness.

PRIOR TO INSTALLATION

Read the manual prior to installation. Technical knowledge is necessary for installation.

The place of installation must be free of moisture and away from heat sources. Phonocar Spa cannot be held responsible for the installation of this product.

TECHNICAL SUPPORT

Phonocar Spa want to provide a fast and suitable resolution should you encounter any technical issues. With this in mind, when contacting Phonocar Spa, try to provide as much Information as possible. This will speed up the process and help us to help you.

For more information go to: phonocar.com

DIP SWITCH settings • Impostazioni DIP SWITCH

IT ATTENZIONE: Effettuare le impostazioni DIP SWITCH con l'interfaccia scollegata.

EN ATTENTION: Make the DIP SWITCH settings with the interface disconnected.

DIP 1

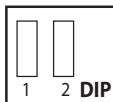
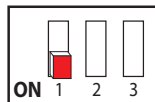

IT Con retrocamera OEM
(ON: YES OFF:NO)
EN With OEM reverse camera
(ON: YES OFF:NO)

DIP 2

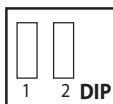

IT Con camera frontale
AFTERMARKET (ON: YES OFF:NO)
EN With aftermarket
front camera (ON: YES OFF:NO)

DIP 3

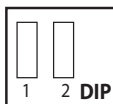
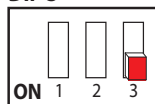

IT Con retrocamera
aftermarket (ON: YES OFF:NO)
EN With aftermarket
reverse camera (ON: YES OFF:NO)

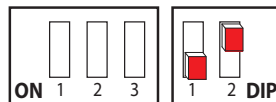

IT DIP 1
Schermo 5.8" - ON
Schermo 6.5" - OFF
DIP 2
Schermo 5.8" - OFF
Schermo 6.5" - OFF

EN DIP 1
Screen 5.8" - ON
Screen 6.5" - OFF
DIP 2
Screen 5.8" - OFF
Screen 6.5" - OFF

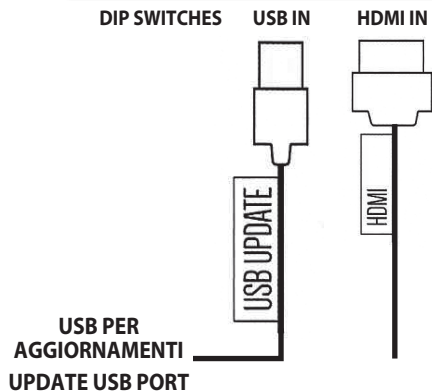
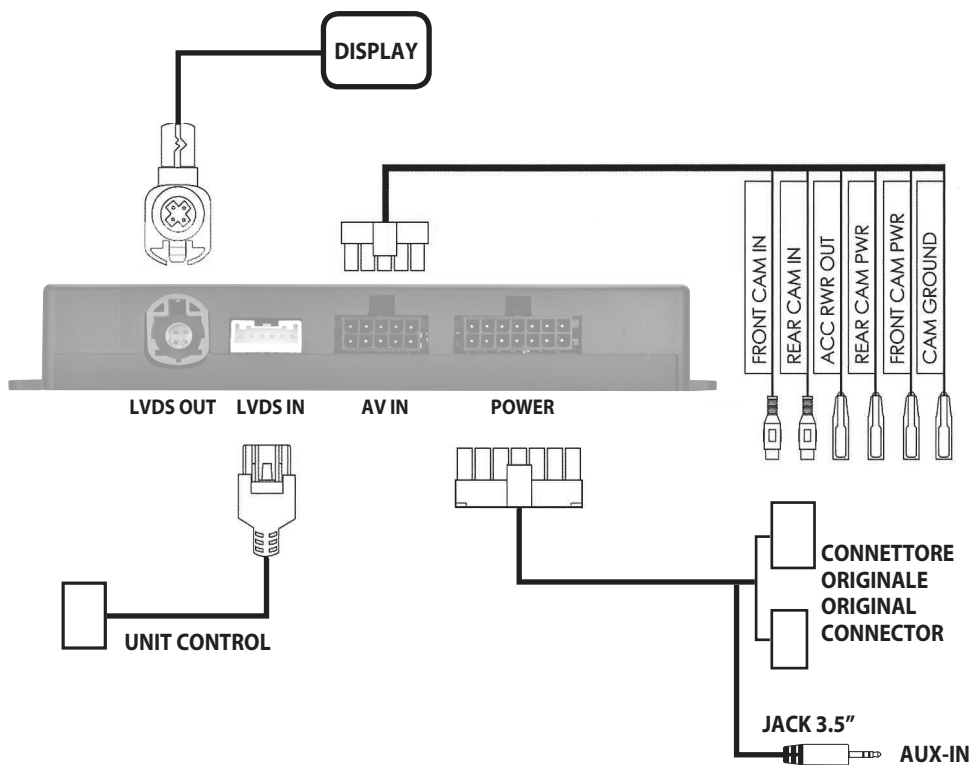



IT
PULSANTE DI CONFIGURAZIONE

Pulsante 1 - Freccia BACK

ACCESSO HDMI

Selezionare AUX IN nel menù delle sorgenti OEM
Tenere premuto **Pulsante 1** per 2 secondi per passare dalla schermata OEM alla schermata Phonocar Multimedia HDMI. Premere 2 volte il **Pulsante 1** per uscire.



Avviso video in movimento - 16 km/h

Premere 2 volte il **Pulsante 1** per disattivare l'avviso video in movimento.

ACCESSO TELECAMERA POSTERIORE E ANTERIORE

Da entrambe le modalità HDMI o OEM

1. Selezionare la retromarcia per attivare la retrocamera.
 2. Deselezionare la retromarcia per passare alla telecamera anteriore after market (se il DIP 2 è su ON)
- Premere 2 volte **Pulsante 1** per disattivare la telecamera anteriore o guidare al di sopra di 16 km/h.



Accesso telecamera anteriore "

Premere 2 volte **Pulsante 1** per accedere alla visualizzazione della telecamera anteriore (se DIP 2 è su ON). Premere 2 volte **Pulsante 1** per uscire.

Visualizza il numero di versione

Tenere premuto il **Pulsante 1** per 8 secondi per accedere alla schermata delle informazioni del firmware.

EN
BUTTON CONFIGURATION

Button 1 - Back Arrow

HDMI ACCESS

Select Aux In from the OEM source menu.
Hold **Button 1** for 2 seconds to switch between OEM screen and Phonocar Multimedia HDMI screen. Double press **Button 1** to exit.

Video In Motion Warning - 16 km/h

Double press **Button 1** to disable the video in motion warning message.

REAR AND FRONT CAMERA ACCESS

From either HDMI mode or OEM mode

1. Select reverse gear for reverse camera.
2. Deselect reverse gear - will go to after market front camera (if DIP 2 ON). Double Press **Button 1** to cancel front camera or drive over 16 km/h.

Front Camera Access

Double Press **Button 1** to enter the front camera screen (if DIP 2 is ON). Double press **Button 1** to exit.

View Version Number

Hold **Button 1** Button for 8 seconds to enter firmware information screen.



FR

L'interface 05959 vous permet d'ajouter une entrée HDMI et une entrée caméra sur l'écran OEM. Grâce à l'HDMI, vous pouvez utiliser votre dispositif Apple ou Android, en utilisant l'écran de votre smartphone, directement sur l'écran d'origine, grâce à la fonction miroir. Les entrées pour les caméras avant et de recul aftermarket sont également fournies de série avec la mini.

APPLICATION

Pour véhicules MERCEDES avec NTG 4.5 avec écran 5,8" et 6,5"

INCLUS DANS LE KIT

Interface Phonocar 05959, câblage pour le véhicule
AVANT L'INSTALLATION

Lire attentivement ce manuel avant toute installation. Le lieu d'installation doit être sec et protégé des sources de chaleur. Le fabricant est déchargé de toute responsabilité concernant l'installation du produit.

ASSISTANCE TECHNIQUE

Dans le but de vous fournir des solutions toujours rapides et appropriées en cas de problèmes techniques, nous vous prions de nous fournir autant d'informations que possible, en cas de demande d'assistance

Pour plus d'informations: phonocar.com

DE

Das Phonocar Interface 05959 ermöglicht den HDMI- und Kamera-Eingang auf dem OEM-Bildschirm. Dank diesem Mini-Plug&Play-Interface können Sie Ihr Apple- oder Android-Gerät über die Spiegelfunktion des Displays Ihres Smartphones direkt auf dem Originalbildschirm bedienen. Kamera-Eingänge für aftermarket Frontal- und Rückfahrkameras sind serienmäßig.

ANWENDUNG

Für MERCEDES-Fahrzeuge mit NTG mit 5,8" und 6,5" Bildschirm.

IM LIEFERUMFANG ENTHALTEN:

Phonocar Interface 05959, Fahrzeugverkabelung.

VOR DER INSTALLATION

Lesen Sie diese Anleitung vor der Installation sorgfältig durch. Der Aufstellungsort muss frei von Feuchtigkeit und vor Wärmequellen geschützt sein, und der Hersteller ist von jeglicher Verantwortung für die Installation des Produkts befreit.

TECHNISCHE UNTERSTÜTZUNG

Um bei technischen Problemen schnelle und angemessene Lösungen zu finden, bitten wir Sie, bei Supportanfragen so viele Informationen wie möglich zur Verfügung zu stellen.

Für weitere Informationen: phonocar.com

Réglages DIP SWITCH • DIP SWITCH einstellungen

FR ATTENTION: Effectuer les réglages DIP SWITCH avec l'interface déconnectée

DE WARNUNG: Nehmen Sie die Einstellungen des DIP-SWITCH vor, wenn das Interface getrennt ist.

DIP 1

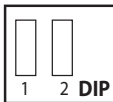
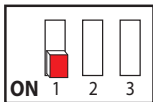

FR Avec camera de recul OEM
(ON: YES OFF:NO)

DE Mit OEM Rückfahrkamera
(ON: YES OFF:NO)

DIP 2

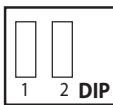
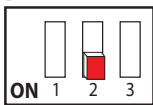

FR Avec camera avant deuxième monte
(ON: YES OFF:NO)

DE Mit AFTERMARKET Front-Kamera
(ON: YES OFF:NO)

DIP 3

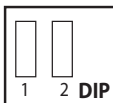
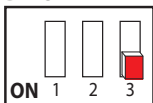

FR Avec camera de recul deuxième monte
(ON: YES OFF:NO)

DE Mit aftermarket Rückfahrkamera
(ON: YES OFF:NO)

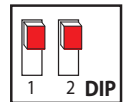

FR DIP 1 - OFF
DIP 2 - OFF

DE DIP 1 - OFF
DIP 2 - OFF

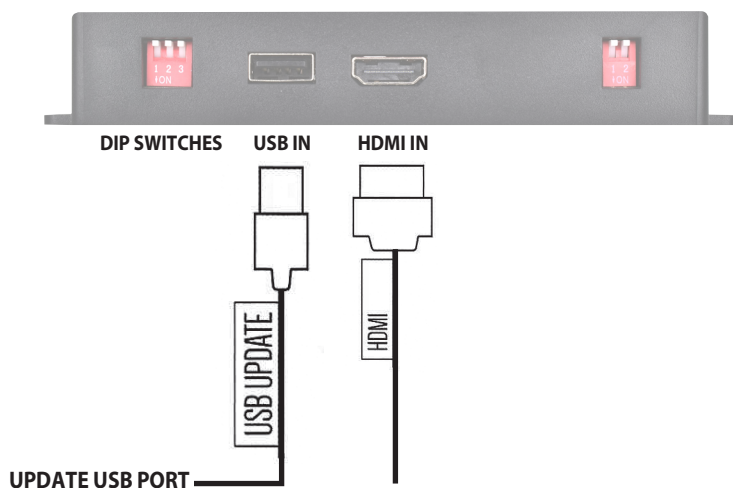
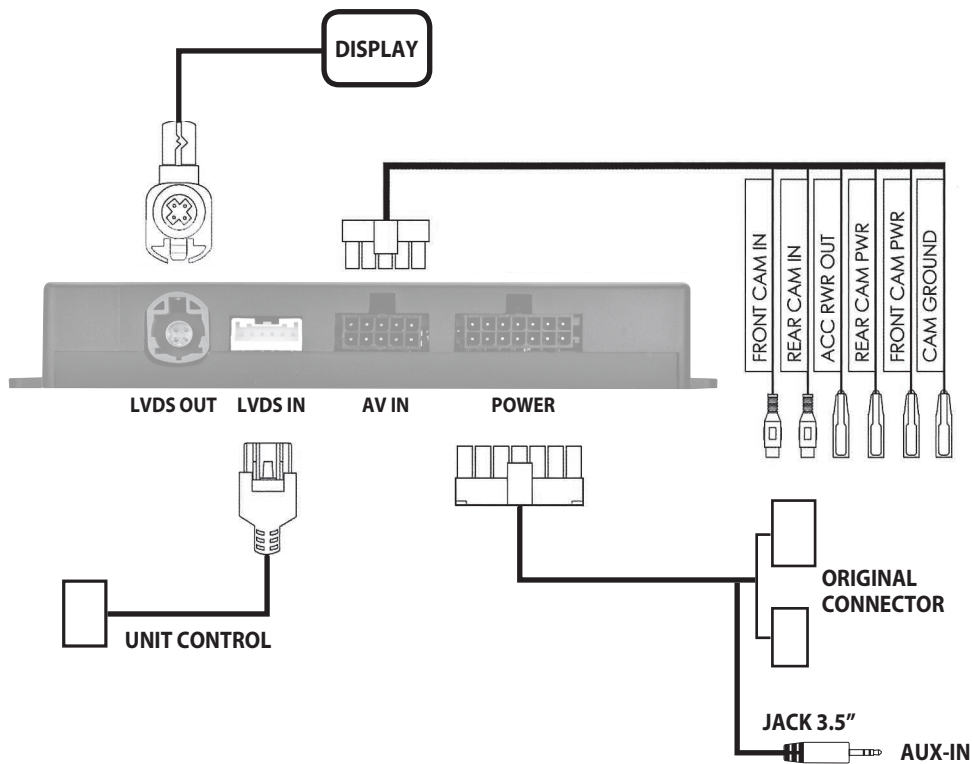



FR TOUCHE DE CONFIGURATION

Touche 1 - Flèche BACK

ACCÈS HDMI

Sélectionnez AUX IN dans le menu des sources OEM. Appuyez sur la **touche 1** pendant 2 secondes pour passer de la visualisation OEM à la visualisation HDMI Phonocar Multimédia. Appuyez 2 fois sur la **Touche 1** pour quitter.



DE KONFIGURATIONSTASTE

Taste 1 - Pfeil BACK

HDMI-ZUGANG

Wählen Sie Aux In aus den OEM-Menüquellen aus. Halten Sie die **Taste 1**, 2 Sekunden lang gedrückt, um zwischen dem OEM-Bildschirm und dem Phonocar Multimedia HDMI-Bildschirm zu wechseln. Drücken Sie die **Taste 1** zweimal, um das Menü zu verlassen.

Message vidéo en mouvement - 16 km/h

Appuyez 2 fois sur la **Touche 1** pour désactiver le message d'avertissement vidéo en mouvement.

Video in Motion Warnung - 16 km/h

Drücken Sie die **Taste 1** zweimal, um den Warnhinweis zu deaktivieren.

ACCÈS CAMÉRAS AVANT ET DE RECU

A partir du mode HDMI ou du mode OEM

1. Sélectionnez la marche arrière pour la caméra de recul.
2. Désélectionnez la marche arrière pour passer à la caméra avant deuxième monte (si le DIP 2 est sur ON). Appuyez 2 fois sur **Touche 1**, pour désactiver la caméra avant, ou conduire à une vitesse supérieure à 16 km/h.

ZUGANG ZUR RÜCKFAHRKAMERA UND FRONTKAMERA

Entweder vom HDMI- oder OEM-Modus aus

1. Wählen Sie den Rückwärtsgang, um die Rückfahrkamera zu aktivieren.
2. Deaktivieren Sie den Rückwärtsgang, um zur Aftermarket Frontkamera zu wechseln (beim eingeschalteten DIP 2). Drücken Sie die **Taste 1** zweimal, um die Frontkamera zu deaktivieren oder fahren Sie über 16 km/h



Accès camera avant

Appuyez 2 fois **Touche 1** pour accéder à la visualisation de la caméra avant (si le DIP 2 est sur ON). Appuyez deux fois sur la **Touche 1** pour quitter le boîtier

Zugang zur Frontkamera

Drücken Sie die **Taste 1** zweimal, um in den Bildschirm der Frontkamera zu gelangen (beim eingeschalteten DIP 2). Drücken Sie die **Taste 1** zweimal, um das Menü zu verlassen.

Afficher le nr. de version

Appuyer sur la **touche 1** pendant 8 secondes pour afficher les informations sur le logiciel.

Versionsnummer anzeigen

Halten Sie die **Taste 1** 8 Sekunden lang gedrückt, um die Firmware-Informationen anzuzeigen.



ES

El interface Phonocar 05959 consiente la entrada HDMI y cámaras en la pantalla original (OEM). Gracias a esta mini interface plug&play es posible utilizar su dispositivo Apple o Android y disfrutar de la función mirror (duplicación de imágenes) del display de tu Smartphone directamente en la pantalla de origen del coche. Entradas para cámara delantera y trasera aftermarket o de origen.

APLICACIÓN

Para vehículos MERCEDES con NTG 4.5, pantalla 5,8"e 6,5".

INCLUIDOS EN EL KIT

Interface Phonocar 05959, cableado completo

ANTES DE LA INSTALACIÓN

Leer atentamente el manual antes de la instalación. Es imprescindible tener un alto conocimiento técnico para proceder a la instalación. El lugar de instalación del interface tiene que estar ausente de humedad y protegido de fuentes de calor, el productor no se hace responsable de la instalación del dispositivo .

SOPORTE

En el intento de ofrecer al cliente rápidas y adecuadas soluciones, en caso de necesitar soportes técnicos, rogamos de informar adecuadamente en los mínimos detalles.

Para más información: www.phonocar.com

Ajustes DIP SWITCH

ES ATENCIÓN: Efectuar los ajustes de DIP SWITCH con el interface desconectado.

DIP 1

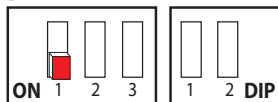

ES Con cámara delantera OEM
(ON: YES OFF:NO)

DIP 2

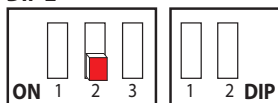

ES Con cámara frontal AFTERMARKET (ON: YES OFF:NO)

DIP 3

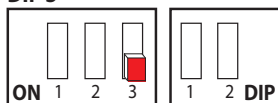

ES Con cámara delantera aftermarket (ON: YES OFF:NO)

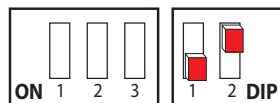

ES DIP 1
Pantalla 5.8" - ON
Pantalla 6.5" - OFF
DIP 2
Pantalla 5.8" - OFF
Pantalla 6.5" - OFF

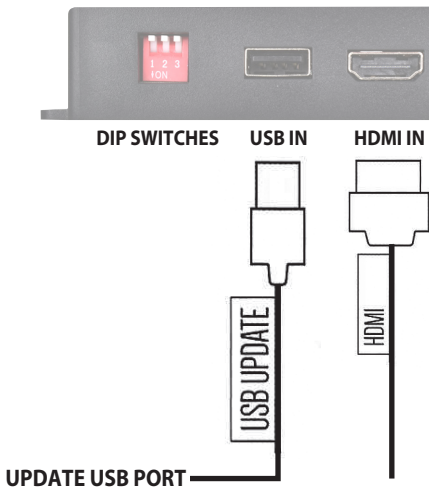
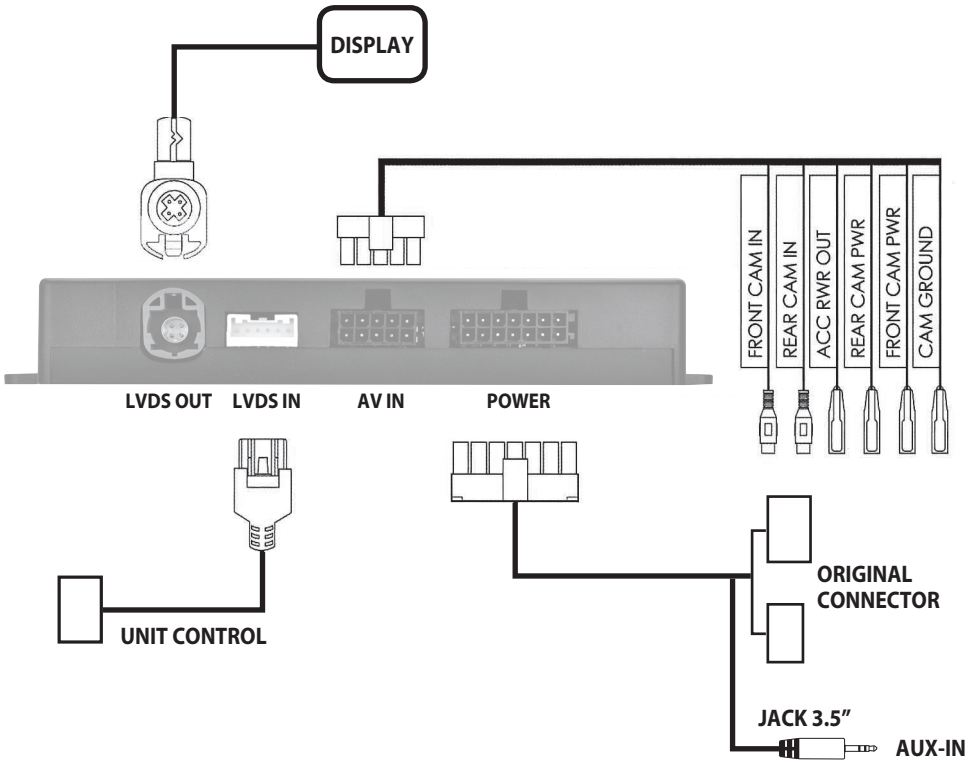



IT
PULSANTE DI CONFIGURAZIONE

Pulsante 1 - Freccia BACK

ACCESSO HDMI

Selezionare AUX IN nel menù delle sorgenti OEM. Tenere premuto **Pulsante 1** per 2 secondi per passare dalla schermata OEM alla schermata Phonocar Multimedia HDMI. Premere 2 volte il **Pulsante 1** per uscire.



Avviso video in movimento - 16 km/h

Premere 2 volte il **Pulsante 1** per disattivare l'avviso video in movimento.

ACCESSO TELECAMERA POSTERIORE E ANTERIORE

Da entrambe le modalità HDMI o OEM

1. Selezionare la retromarcia per attivare la retrocamera.
2. Deselezionare la retromarcia per passare alla telecamera anteriore after market (se il DIP 2 è su ON)

Premere 2 volte **Pulsante 1** per disattivare la telecamera anteriore o guidare al di sopra di 16 km/h.



Accesso telecamera anteriore "

Premere 2 volte **Pulsante 1** per accedere alla visualizzazione della telecamera anteriore (se DIP 2 è su ON). Premere 2 volte **Pulsante 1** per uscire.

Visualizza il numero di versione

Tenere premuto il **Pulsante 1** per 8 secondi per accedere alla schermata delle informazioni del firmware.

CONFIGURACIÓN TECLADO

Tecla 1 – Flecha Back

ACCESO HDMI

Seleccionar AUX IN de las fuentes del menú OEM. Tener presionada la **tecla 1** durante 2 segundos para pasar de la pantalla OEM a la pantalla Phonocar Multimedia HDMI. Pulsar 2 veces la **Tecla 1** para salir.

Aviso de video en movimiento - 16 km/h

Pulsar 2 veces la **Tecla 1** para desactivar el aviso de video en movimiento.

ACCESO A LA CAMARA FRONTAL Y TRASERA

Desde ambos modo HDMI o bien OEM

1. Seleccionar la marcha atrás para activar la retro cámara.
2. Deseleccionar la marcha atrás para pasar a la cámara delantera after market (si DIP 2 es ON).

Pulsar 2 veces la **Tecla 1** para desactivar la cámara delantera o superar la velocidad de 16 km/h.

Acceso a la cámara frontal

Pulsar 2 veces la **Tecla 1** para acceder a la visualización de la cámara frontal (si DIP 2 es ON). Pulsar 2 veces la **tecla 1** para salir

Visualizar el número de versión

Pulsar la **Tecla 1** durante 8 segundos para visualizar la información sobre el firmware.

