



05958

INTERFACCIA VIDEO HDMI
HDMI VIDEO INTERFACE

PLUG&PLAY

FORD



Sync 3 system + 8" display (NO TOUCHSCREEN)

C-Max 2016>, Edge 2016>, Escape 2016>,
Explorer 2017>, Flex 2016>, Focus 2017>,
Fusion 2017>, Galaxy 2016>, Kuga 2016>,
Mustang 2016>, Mondeo 2016>,
S-Max 2016>, Taurus 2017>, Expedition 2016>,
F-150 2017>, F250 2017>, F350 2017>,
F450 2017>, Ranger 2017>

Istruzioni di montaggio **IT**

Installation instructions **EN**

Instructions de montage **FR**

Montageanleitung **DE**

Instrucciones para el montaje **ES**



IT

L'interfaccia Phonocar 05958 consente l'ingresso HDMI e telecamera sullo schermo OEM.

Grazie a questa mini interfaccia plug&play è possibile utilizzare il tuo dispositivo Apple o Android sfruttando la funzione mirror del display del tuo smartphone direttamente sullo schermo originale. Ingressi per telecamera anteriore e posteriore aftermarket di serie.

APPLICAZIONE

Per veicoli Ford con sistema Sync3.

INCLUSI NEL KIT :

Interfaccia Phonocar 05958, cablaggio auto.

PRIMA DELL'INSTALLAZIONE

Leggere con attenzione il manuale prima dell'installazione. E' necessario essere in possesso di conoscenze tecniche per procedere all'installazione. Il luogo di installazione deve essere privo di umidità e al riparo da fonti di calore. Il produttore è sollevato da ogni responsabilità circa l'installazione del prodotto.

SUPPORTO

Nell'intento di fornire al cliente soluzioni rapide e adeguate in caso di problemi tecnici, si prega di fornire il maggior numero di informazioni possibili, in caso di richiesta di supporto.

Per maggiori informazioni: phonocar.com

EN

The interface 05958 allows HDMI & Camera input to the OEM screen.

This plug and play Mini interface adds HDMI to connect your Apple or Android device, allowing you to mirror your smartphone display on the vehicle's original screen. Inputs for front and rear aftermarket cameras also come as standard with the mini.

APPLICATION

For Ford vehicles with Sync3 system.

KIT INCLUDES

Phonocar 05958 interface, vehicle Harness.

PRIOR TO INSTALLATION

Read the manual prior to installation. Technical knowledge is necessary for installation. The place of installation must be free of moisture and away from heat sources. Phonocar Spa cannot be held responsible for the installation of this product.

TECHNICAL SUPPORT

Phonocar Spa want to provide a fast and suitable resolution should you encounter any technical issues. With this in mind, when contacting Phonocar Spa, try to provide as much Information as possible. This will speed up the process and help us to help you.

For more information go to: phonocar.com

DIP SWITCH settings • Impostazioni DIP SWITCH

IT ATTENZIONE: Effettuare le impostazioni DIP SWITCH con l'interfaccia scollegata.

EN ATTENTION: Make the DIP SWITCH settings with the interface disconnected.

DIP 1

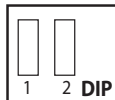
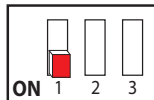

IT Con retrocamera OEM (ON: YES OFF:NO)

EN With OEM reverse camera (ON: YES OFF:NO)

DIP 2

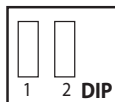

IT Con camera frontale AFTERMARKET (ON: YES OFF:NO)

EN With aftermarket front camera (ON: YES OFF:NO)

DIP 3

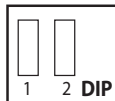
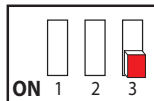

IT Con retrocamera aftermarket (ON: YES OFF:NO)

EN With aftermarket reverse camera (ON: YES OFF:NO)

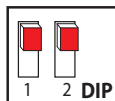

IT DIP 1 - OFF
DIP 2 - OFF

EN DIP 1 - OFF
DIP 2 - OFF

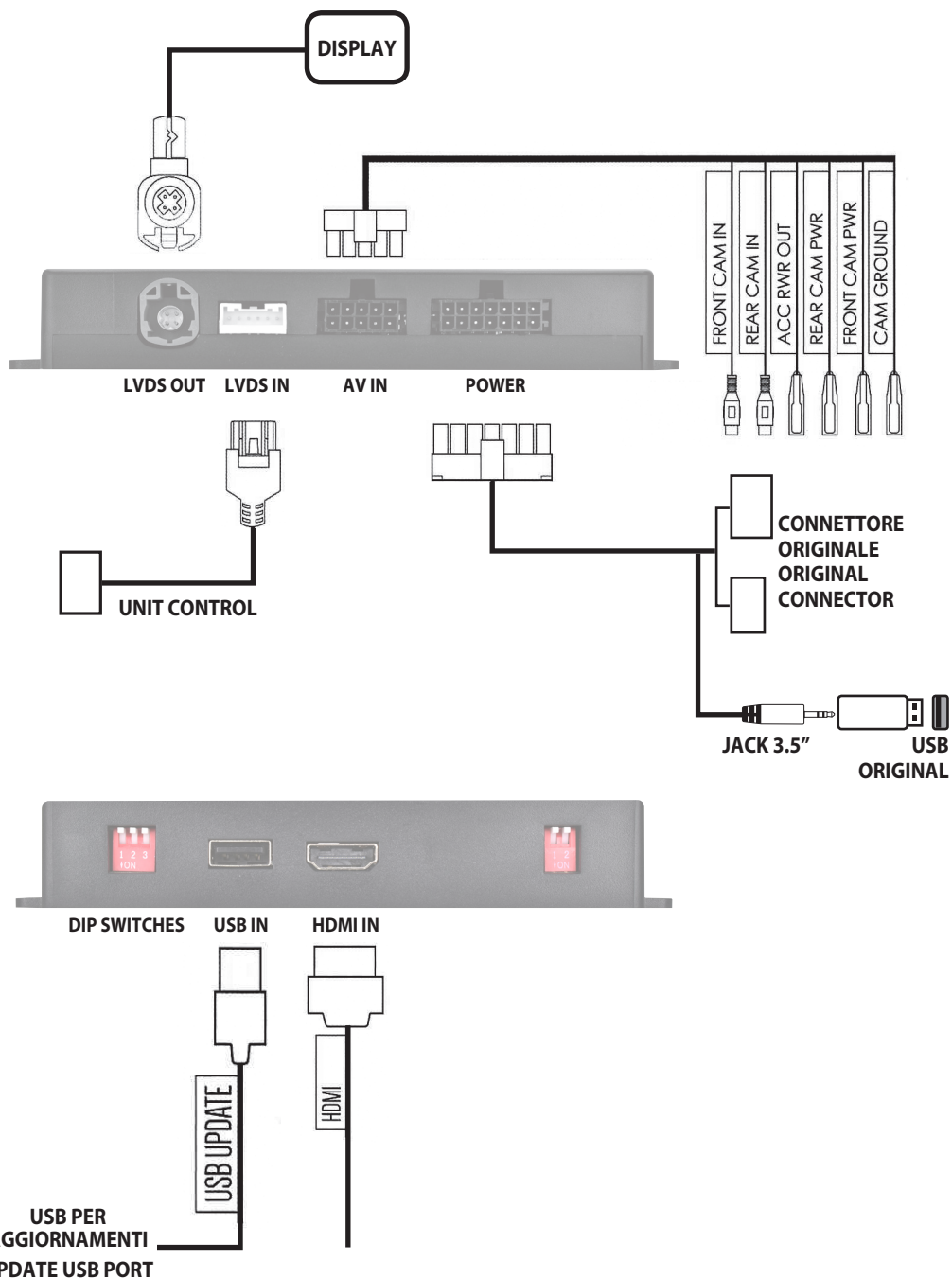

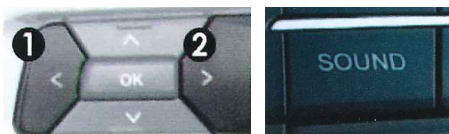

IT

PULSANTE DI CONFIGURAZIONE

Pulsante 1 - Freccia sinistra (volante) o pulsante SOUND sulla centralina OEM.

Pulsante 2 - Freccia destra (volante).

ACCESSO HDMI

Collegare il dongle USB in dotazione all'ingresso USB Sync **. Selezionare la sorgente USB dalle sorgenti del menu OEM, il dongle verrà visualizzato come 'USB AUX'.

Tenere premuto **Pulsante 1** per 2 secondi per passare dalla schermata OEM alla schermata Phonocar Multimedia HDMI.



Avviso video in movimento - 16 km/h

Tenere premuto **Pulsante 2** (o premere l'angolo superiore destro del touch screen) per disabilitare il messaggio di avviso video in movimento

ACCESSO TELECAMERA POSTERIORE E ANTERIORE

Da entrambe le modalità HDMI o OEM

1. Selezionare la retromarcia per attivare la retrocamera.
2. Deselezionare la retromarcia per passare alla telecamera anteriore after market (se il DIP 2 è su ON) Premere l'angolo superiore destro dello schermo per disattivare la telecamera anteriore o guidare sopra i 16 km/h.



Accesso telecamera anteriore

Tenere premuto PULSANTE 2 per 2 secondi per accedere alla visualizzazione della telecamera anteriore (se il DIP 2 è su ON) o premere due volte il tasto SOUND sulla centralina OEM.

Visualizza il numero di versione

Tenere premuto il **Pulsante 1** per 8 secondi per accedere alla schermata delle informazioni del firmware.

**N.B potrebbe esserci un leggero ritardo di sincronizzazione audio lip sync a livello HDMI, dovuto al tempo tampone per l'attivazione audio USB del sistema OEM. Questo fattore dipende dalle specifiche tecniche dell'allestimento originale del costruttore.

EN

BUTTON CONFIGURATION

Button 1 - Left arrow (steering wheel) or SOUND button on OEM head unit.

Button 2 - Right arrow (steering wheel)

HDMI ACCESS

Connect the USB dongle supplied to the vehicles Sync USB input**. Select USB source from the OEM menu sources. The dongle will appear as 'USB AUX'.

Hold **Button 1** for 2 seconds to switch between OEM screen and Phonocar Multimedia HDMI screen.

Video In Motion Warning - 16 km/h

Hold **Button 2** (or press top right corner of touch screen) to disable the video in motion warning message.

REAR AND FRONT CAMERA ACCESS

From either HDMI mode or OEM mode

1. Select reverse gear for reverse camera.
2. Deselect reverse gear - will go to after market front camera (if DIP 2 ON). Press top right corner of screen to cancel front camera or drive over 16 km/h.

Front Camera Access

Hold **Button 2** for 2 seconds to enter the front camera screen (if DIP 2 is ON) or double press SOUND button on OEM head unit.

View Version Number

Hold **Button 1** for 8 seconds to enter firmware information screen

** Note that there may be a slight delay in HDM I audio lip sync , due to the USB audio buffer time of the OEM system. This is dependant on manufacturer original equipment specification.

**FR**

L'interface 05958 permet de rajouter une entrée HDMI et une entrée caméra sur l'écran OEM. Grâce au HDMI, vous pouvez utiliser votre dispositif Apple ou Android directement sur l'écran d'origine, ceci en exploitant la fonction miroir de l'afficheur du smartphone. Entrées d'origine pour caméras avant et de recul deuxième monte.

APPLICATION

Pour véhicules Ford avec système Sync3

INCLUS DANS LE KIT

Interface Phonocar 05958, câblage pour le véhicule

AVANT L'INSTALLATION

Lire attentivement cette notice avant toute installation. L'installation doit être faite par du personnel spécialisé. Le lieu d'installation doit être sec et à l'abri des sources de chaleur. Le producteur n'a aucune responsabilité concernant l'installation du produit.

ASSISTANCE TECHNIQUE

Dans le but de fournir des solutions rapides et appropriées en cas de problèmes techniques, nous vous invitons à nous donner autant d'informations possibles, lors de la demande d'assistance.

Pour plus d'informations: phonocar.com

DE

Das Phonocar Interface 05958 ermöglicht den HDMI- und Kamera-Eingang auf dem OEM-Bildschirm. Dank diesem Mini-Plug&Play-Interface können Sie Ihr Apple- oder Android-Gerät über die Spiegelfunktion des Displays Ihres Smartphones direkt auf dem Originalbildschirm bedienen. Kameraeingänge für aftermarket Frontal- und Rückfahrkameras sind serienmäßig.

ANWENDUNG

Für Ford-Fahrzeuge mit Sync3-System.

IM LIEFERUMFANG ENTHALTEN:

Phonocar 05958 Interface Fahrzeugverkabelung.

VOR DER INSTALLATION

Lesen Sie diese Anleitung vor der Installation sorgfältig durch. Der Aufstellungsort muss frei von Feuchtigkeit und vor Wärmequellen geschützt sein.

Der Hersteller ist von jeglicher Verantwortung für die Installation des Produkts befreit.

TECHNISCHE UNTERSTÜTZUNG

Um bei technischen Problemen schnelle und angemessene Lösungen zu finden, bitten wir Sie, bei Supportanfragen so viele Informationen wie möglich zur Verfügung zu stellen.

Für weitere Informationen: phonocar.com

Réglages DIP SWITCH • DIP SWITCH einstellungen

FR ATTENTION: Effectuer les réglages DIP SWITCH avec l'interface déconnectée

DE WARNUNG: Nehmen Sie die Einstellungen des DIP-SWITCH vor, wenn das Interface getrennt ist.

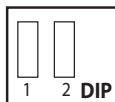
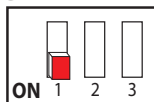
DIP 1

FR Avec camera de recul OEM
(ON: YES OFF:NO)

DE Mit OEM Rückfahrkamera
(ON: YES OFF:NO)

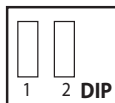
DIP 2

FR Avec camera avant deuxième monte
(ON: YES OFF:NO)

DE Mit AFTERMARKET Front-Kamera
(ON: YES OFF:NO)

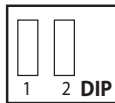
DIP 3

FR Avec camera de recul deuxième monte
(ON: YES OFF:NO)

DE Mit aftermarket Rückfahrkamera
(ON: YES OFF:NO)

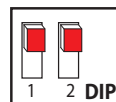

FR DIP 1 - OFF
DIP 2 - OFF

DE DIP 1 - OFF
DIP 2 - OFF

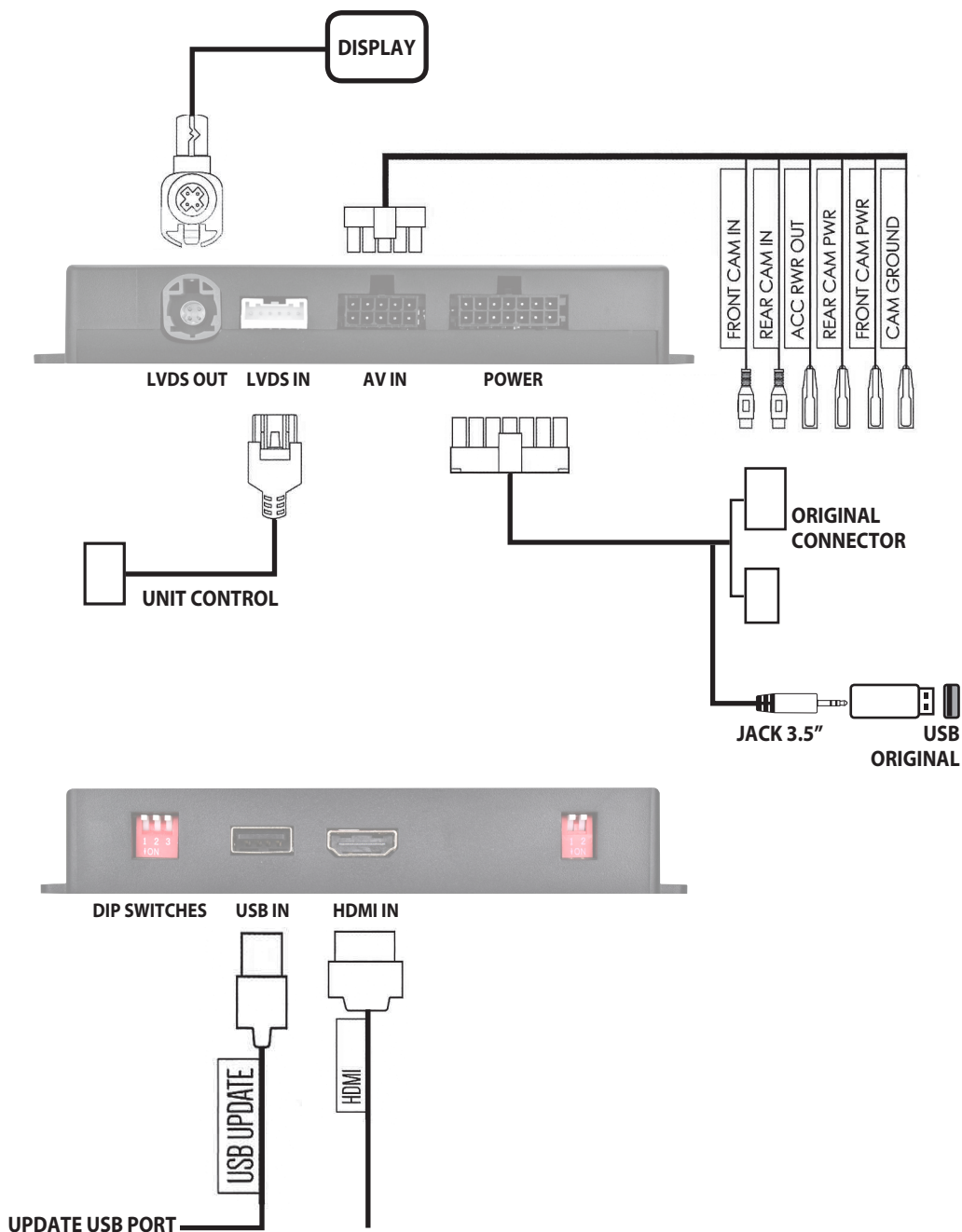

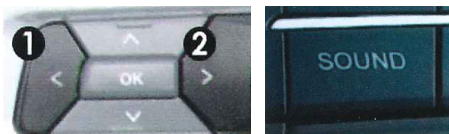

FR

PULSANTE DI CONFIGURAZIONE

Pulsante 1 - Freccia sinistra (volante) o pulsante SOUND sulla centralina OEM.

Pulsante 2 - Freccia destra (volante).

ACCESSO HDMI

Collegare il dongle USB in dotazione all'ingresso USB Sync **. Selezionare la sorgente USB dalle sorgenti del menu OEM, il dongle verrà visualizzato come 'USB AUX'.

Tenere premuto **Pulsante 1** per 2 secondi per passare dalla schermata OEM alla schermata Phonocar Multimedia HDMI.



Avviso video in movimento - 16 km/h

Tenere premuto **Pulsante 2** (o premere l'angolo superiore destro del touch screen) per disattivare il messaggio di avviso video in movimento

ACCESSO TELECAMERA POSTERIORE E ANTERIORE

Da entrambe le modalità HDMI o OEM

1. Selezionare la retromarcia per attivare la retrocamera.
2. Deselezionare la retromarcia per passare alla telecamera anteriore after market (se il DIP 2 è su ON) Premere l'angolo superiore destro dello schermo per disattivare la telecamera anteriore o guidare sopra i 16 km/h.



Accesso telecamera anteriore

Tenere premuto **PULSANTE 2** per 2 secondi per accedere alla visualizzazione della telecamera anteriore (se il DIP 2 è su ON) o premere due volte il tasto SOUND sulla centralina OEM.

Visualizza il numero di versione

Tenere premuto il **Pulsante 1** per 8 secondi per accedere alla schermata delle informazioni del firmware.

**N.B potrebbe esserci un leggero ritardo di sincronizzazione audio lip sync a livello HDMI, dovuto al tempo tampona per l'attivazione audio USB del sistema OEM. Questo fattore dipende dalle specifiche tecniche dell'allestimento originale del costruttore.

DE

TOUCHE DE CONFIGURATION

Touche 1 - Flèche gauche (volant) ou touche SOUND sur le boîtier de control OEM.

Touche 2 - Flèche droite (volant)

ACCÈS HDMI

Branchez le dongle USB fourni à l'entrée Sync USB du véhicule **. Sélectionnez la source USB dans le menu OEM. Le dongle sera affiché comme 'USB AUX'. Faire pression sur la touche 1 pendant 2 secondes pour passer de la visualisation OEM à la visualisation HDMI Phonocar Multimédia

Message vidéo en mouvement - 16 km/h

Appuyez quelques secondes sur Touche 2 (ou appuyez sur le coin supérieur droit de l'écran tactile) pour désactiver le message d'avertissement vidéo en mouvement.

ACCÈS CAMÉRAS AVANT ET DE RECU

A partir du mode HDMI ou du mode OEM

1. Sélectionnez la marche arrière pour la caméra de recul.
2. Désélectionnez la marche arrière pour passer à la caméra avant deuxième monte (si le DIP 2 est sur ON). Pour désactiver la caméra avant, appuyez sur le coin supérieur droit de l'écran ou conduire à une vitesse supérieure à 16 km/h.

Accès camera avant

Appuyez pendant 2 secondes sur la touche 2 pour accéder à la visualisation de la caméra avant (si le DIP 2 est sur ON) ou appuyez deux fois sur la touche SOUND sur le boîtier de control OEM.

Afficher le nr. de version

Faire pression sur la touche 1 pendant 8 secondes pour accéder à la page des informations du logiciel.

**N.B : il pourrait y avoir un léger retard dans la synchronisation audio lip sync sur le HDMI, celui-ci est dû au temps nécessaire pour l'activation audio USB du système OEM. Ce facteur dépend des caractéristiques techniques de l'équipement d'origine du fabricant.



ES

El interface Phonocar 05958 consiente la entrada HDMI y cámaras en la pantalla original (OEM). Gracias a esta mini interface plug&play es posible utilizar su dispositivo Apple o Android y disfrutar de la función mirror (duplicación de imágenes) del display de tu Smartphone directamente en la pantalla de origen del coche. Entradas para cámara delantera y trasera aftermarket o de origen.

APLICACIÓN

Para vehículos Ford con sistema Sync3.

INCLUIDOS EN EL KIT

Interface Phonocar 05958, cableado completo

ANTES DE LA INSTALACIÓN

Leer atentamente el manual antes de la instalación. Es imprescindible tener un alto conocimiento técnico para proceder a la instalación. El lugar de instalación del interface tiene que estar ausente de humedad y protegido de fuentes de calor, el productor no se hace responsable de la instalación del dispositivo.

SOPORTE

En el intento de ofrecer al cliente rápidas y adecuadas soluciones, en caso de necesitar soportes técnicos, rogamos de informar adecuadamente en los mínimos detalles.

Para más información: www.phonocar.com

Ajustes DIP SWITCH

ES ATENCIÓN: Efectuar los ajustes de DIP SWITCH con el interface desconectado.

DIP 1

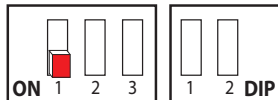

ES Con cámara delantera OEM
(ON: YES OFF:NO)

DIP 2

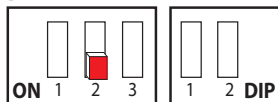

ES Con cámara frontal AFTERMARKET (ON: YES OFF:NO)

DIP 3

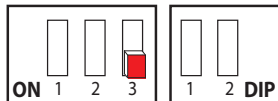

ES Con cámara delantera aftermarket (ON: YES OFF:NO)

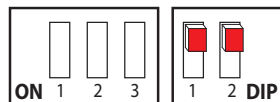

ES DIP 1 - OFF
DIP 2 - OFF

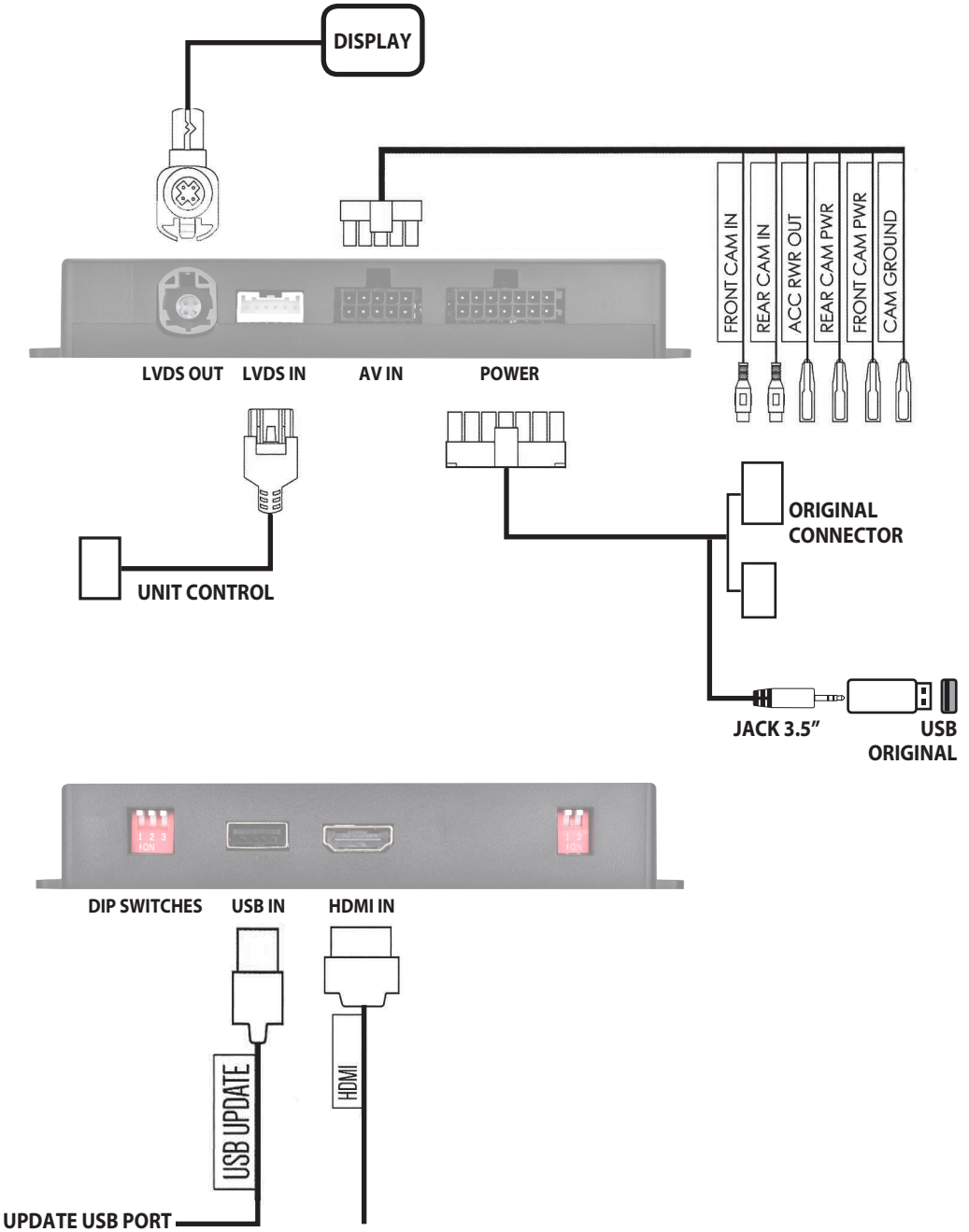

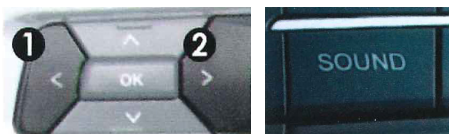

ES

CONFIGURACIÓN TECLADO

Tecla 1 – Flecha izquierda (volante) o tecla SOUND en la centralita OEM.

TECLA 2 – Flecha derecha (volante)

ACCESO HDMI

Conectar el USB dongle en dotación a la entrada Sync USB **. Seleccionar USB de las fuentes del menú OEM. El dongle será visualizado como 'USB AUX'.

Tener presionada la **tecla 1** durante 2 segundos para pasar de la pantalla OEM a la pantalla Phonocar Multimedia HDMI.

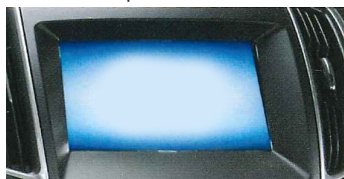
**Aviso de video en movimiento - 16 km/h**

Tener pulsada la **Tecla 2** (o presionar el ángulo superior derecho de la pantalla táctil) para deshabilitar el mensaje de video en movimiento.

ACCESO A LA CAMARA FRONTAL Y TRASERA

Desde ambos modo HDMI o bien OEM

1. Seleccionar la marcha atrás para activar la retro cámara.
2. Deseleccionar la marcha atrás para pasar a la cámara delantera after market (si DIP 2 es ON). Pulsar el ángulo superior derecho de la pantalla táctil para desactivar la cámara delantera o superar la velocidad de 16 km/h.

**Acceso a la cámara frontal**

Pulsar la Tecla 2 durante 2 segundos para acceder a la visualización de la cámara frontal (si DIP 2 es ON) o bien pulsar 2 veces la tecla SOUND en la centralita OEM.

Visualizar el número de versión

Pulsar la Tecla 1 durante 8 segundos para visualizar la información sobre el firmware.

** NB. Puede haber un ligero retraso de sincronización audio lip sync, en HDM debido al tiempo tampón para la activación audio USB del sistema OEM. Este factor depende de las especificaciones técnicas del equipo de origen del fabricante.

