

KEY FEATURES

- 1" (25,4 mm) exit high frequency compression driver
- 1,75" (44,4) DUO double layer in/out aluminium voice coil
- Sensitivity: 109 dB (1W / 1m)
- 140 W program power above 1,5 kHz
- PM4 polymer diaphragm for natural sound reproduction
- Aluminium cover
- FEA optimized ferrite motor structure

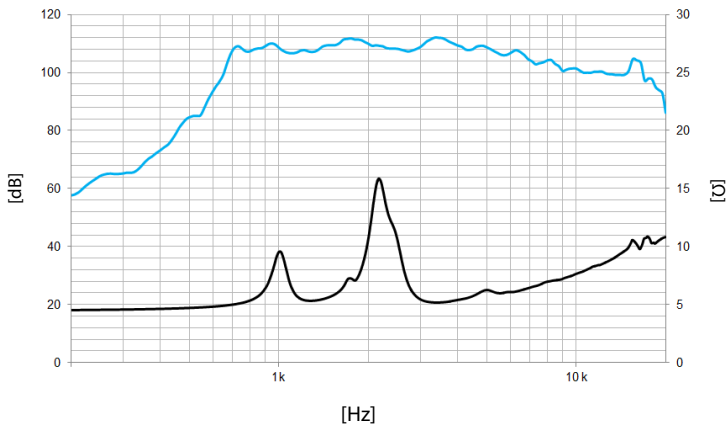

Note: On axis frequency response measured coupled to TD-164 horn in anechoic chamber, 1W @ 1m

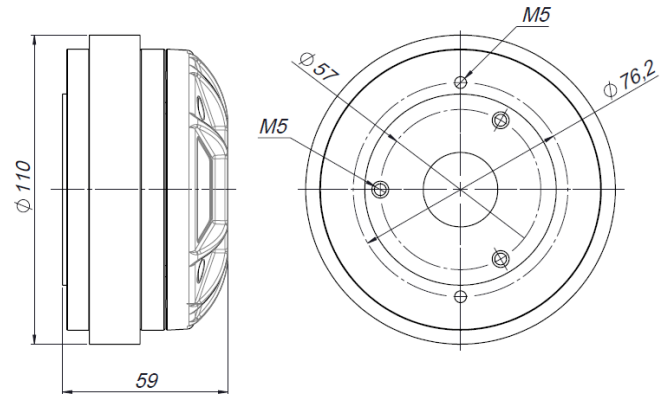

TECHNICAL SPECIFICATIONS

Throat diameter	25,4 mm	1 in
Rated impedance	8 Ω	
Minimum impedance	5,2 Ω	
D.C. Resistance	4,4 Ω	
Power capacity ¹	70 W _{AES} above 1,5 kHz	
Program power ²	140 W above 1,5 kHz	
Sensitivity ³	109 dB 1W / 1m @ Z _N coupled to TD-164	
Frequency range	0,7 - 19 kHz	
Recommended crossover	1,5 kHz or higher (12 dB/oct min)	
Voice coil diameter	44,4 mm	1,75 in
Flux density	1,5 T	

Notes:

¹ The power capacity is determined according to AES2-1984 (r2003) standard.

² Program power is defined as the transducer's ability to handle normal music program material.

³ Sensitivity was measured at 1m distance, on axis, with 1W input, averaged in the range 1 - 7 kHz

MOUNTING INFORMATION

Overall diameter	110 mm	4,3 in
Depth	59 mm	2,3 in
Mounting	Three M5 threaded holes, 120° apart on 57 mm (2,24 in) diameter circle Two M5 threaded holes, 180° apart on 76,2 mm (3 in) diameter circle	
Net weight	1,8 kg	4,0 lb
Shipping weight	1,9 kg	4,2 lb