



400.2D EVO

400.4D EVO

800.4D EVO

Owner's Manual

English

PACKAGE CONTENTS

1 EVO Amplifier

1 Owner's Manual

1 Allen wrench 2.5mm

1 Allen wrench 4mm

1 Promotional Sticker

Dear Customer,

Congratulations on acquiring a product with the highest quality and technology!

The SounDigital products are developed to assure maximum efficiency and reability to your sound system.

Class D Amplifiers:

The main characteristics of Class D amplifiers are: audio quality, efficiency, versatility and compact design. Here are the advantages of these characteristics:

Audio Quality – Class D amplifiers used to have a limited response in the past and they used to have a worse performance regarding higher frequencies than Class AB amps, despite being more efficient. Introducing new technologies, SounDigital developed a Class D amplifier superior to the Class AB ones in efficiency and performance.

Efficiency – The SounDigital Class D amplifiers have a total efficiency (power source + output) higher than 60%, assuring a battery consumption and a heating lower than the expected.

Versatility of uses – The flat response of all the frequencies of SounDigital amplifiers allows them to be used in all the kinds of systems: SPL, Sound Quality, Trio Eletrico and Pancadao, meeting the needs with extreme quality.

Compact design – The high efficiency and technology allow our amplifiers to be really compact, making it easy to install them in vehicles where you have limited space.

IMPORTANT INFO

Read this manual and follow its instructions and information carefully. It contains extremely important information to have your amplifier working properly. If you feel the need to contact our Tech Support, you can reach our technicians through the e-mail info@sounddigitalusa.com.

IMPORTANT INFO

We recommend the use of SounDigital original accessories for a better performance. The crossovers, RCA cables and voltmeters offered by SounDigital follow the same quality standards as our amplifiers, assuring an excellent quality and high power sound system to our customers.

To know our complete line of amplifiers and accessories, visit www.sounddigitalusa.com.



Warning!

This "Warning" sign alerts the user of important info. Not following this instructions may cause injuries to the user or damage to the equipment.

- ▶ To prevent injuries to the user or damage to the amplifier, read all the safety instructions written on this manual;
- ▶ If you have questions about the installation of this equipment, get in touch with our tech support or with a professional specialized in car audio installation;
- ▶ Before proceeding with the installation of any electric equipment on your vehicle, unplug the negative (-) terminal of the battery to avoid fires, injuries or damages;
- ▶ Use your sound system safely, exposure to continuous sound pressure over 85 dB may cause irreversible hearing loss.

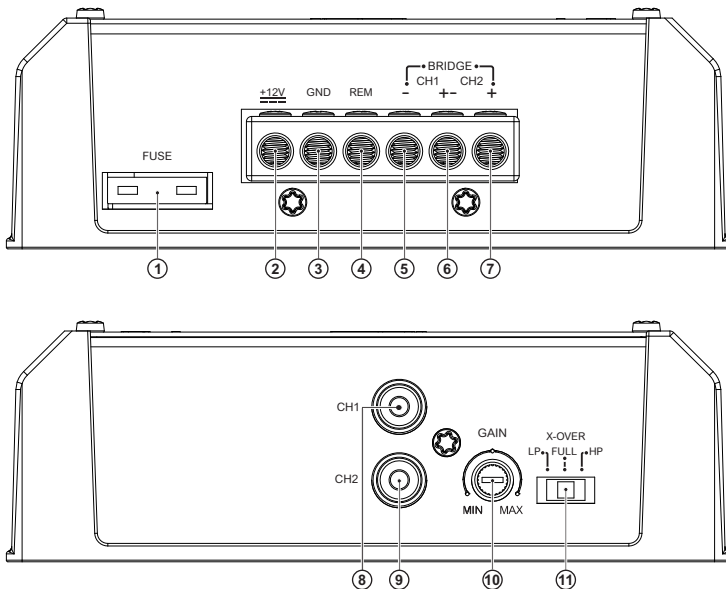

- ① Protection fuse 30A;
- ② Positive power supply connector (+12V);
- ③ Negative power supply connector (GND);
- ④ Remote power supply connector (REM);
- ⑤ Negative speaker connector (-) CH1;
- ⑥ Positive speaker connector (+) CH1 and negative (-) CH2;
- ⑦ Positive speaker connector (+) CH2;
- ⑧ Audio input RCA connector (CH1);
- ⑨ Audio input RCA connector (CH2).
- ⑩ Gain control CH1 and CH2;
- ⑪ Selector switch crossover CH1 and CH2.

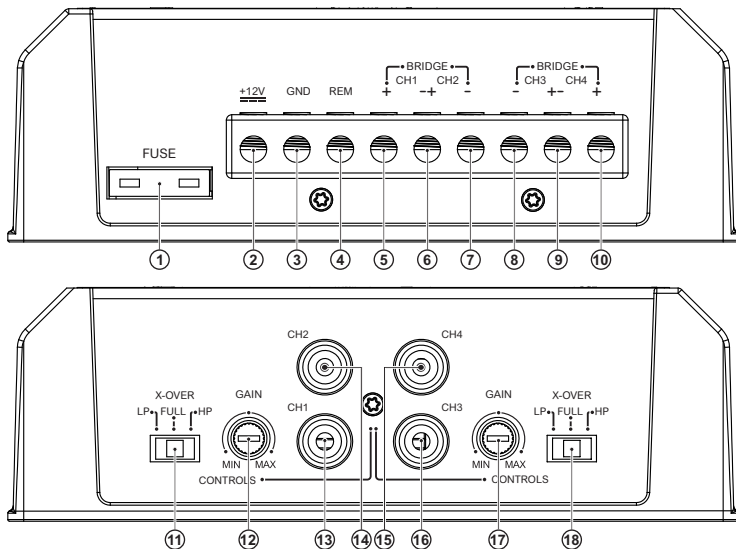

- | | |
|--|---|
| <p>① Protection Fuse 30A;</p> <p>② Positive power supply connector (+12V);</p> <p>③ Negative power supply connector (GND);</p> <p>④ Power supply connector (REM);</p> <p>⑤ Positive speaker connector (+) CH1;</p> <p>⑥ Negative speaker connector (-) CH1 and positive (+) CH2;</p> <p>⑦ Negative speaker connector (-) CH2;</p> <p>⑧ Negative speaker connector (-) CH3;</p> <p>⑨ Positive speaker connector (+) CH3 and negative (-) CH4;</p> | <p>⑩ Positive speaker connector (+) CH4;</p> <p>⑪ Selector switch of crossover CH1 and CH2;</p> <p>⑫ Gain control CH1 and CH2;</p> <p>⑬ Audio input RCA CH1 connector;</p> <p>⑭ Audio input RCA CH2 connector;</p> <p>⑮ Audio input RCA CH4 connector;</p> <p>⑯ Audio output RCA CH3 connector;</p> <p>⑰ Gain control CH3 and CH4;</p> <p>⑱ Selector switch of crossover CH3 and CH4.</p> |
|--|---|

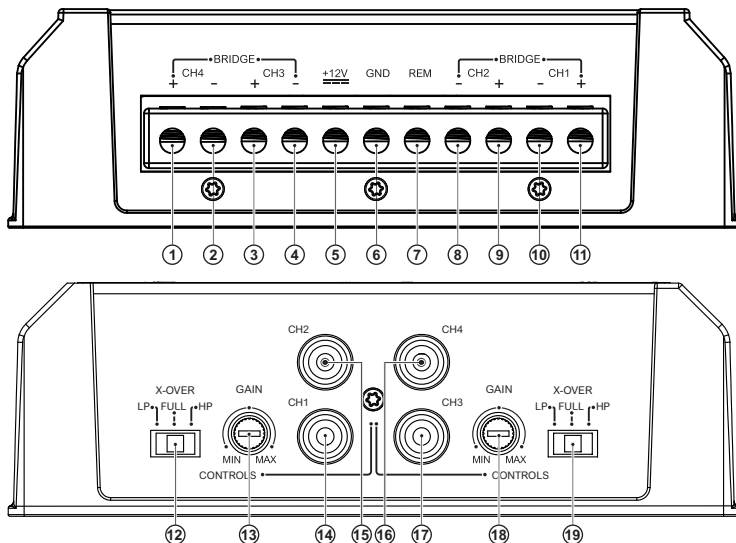

- ① Positive audio output connector (+) CH4;
- ② Negative audio output connector (-) CH4;
- ③ Positive audio output connector (+) CH3;
- ④ Negative audio output connector (-) CH3;
- ⑤ Positive power supply connector (+12V);
- ⑥ Negative power supply connector (GND);
- ⑦ Power supply connector (REM);
- ⑧ Negative audio output connector (-) CH2;
- ⑨ Positive audio output connector (+) CH2;

- ⑩ Negative audio output connector (-) CH1;
- ⑪ Positive audio output connector (+) CH1;
- ⑫ Selector switch of crossover CH1 and CH2;
- ⑬ Gain control CH1 and CH2;
- ⑭ Audio input RCA CH1 connector;
- ⑮ Audio input RCA CH2 connector;
- ⑯ Audio input RCA CH4 connector;
- ⑰ Audio output RCA CH3 connector;
- ⑱ Gain control CH3 and CH4;
- ⑲ Selector switch of crossover CH3 and CH4.

For proper operation, your Soundigital amplifier needs the correct size of cables and electrical system. Refer to "Power supply table" in the technical specifications in this manual to get this information.



Warning!

The protection fuse/circuit breaker must be installed at a max distance of 30cm (1 foot) from the battery.

Use good quality cables (copper if possible) for the connections to the amplifier.

Installation Tips

- ▶ The ground cable should be the shortest possible and should be connected to the chassis of the vehicle. The surface should be sanded at the contact point to create a clean, metal-to-metal connection between the chassis and the termination of the ground wire.

Remove de paint between the terminal and chassis →

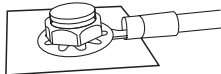

- ▶ Keep the RCA cables together, but away from the power or the audio output cables and away from electric equipment such as electronic fuel injection centrals, electric engines, etc.



Warning!

Never connect or disconnect the RCA cables with the amplifier on, because it may damage the headunit or the amplifier.

- ▶ When passing cables through metallic walls, use rubber grommets to avoid damage to the cable and short circuits.
- ▶ Choose a proper place to install the amplifier and avoid blocking the side ventilation panels.

- ▶ Securely mount the amplifier so that it does not come loose in the event of a collision or sudden jolt to the vehicle. Avoid mounting it on metallic parts of the vehicle, because it may cause an earth loop (you might have noise issues).



Warning!

Be careful when drilling holes in the vehicle. Verify if you're not drilling holes in the fuel tank, brake lines or electrical cables of the vehicle.

- ▶ Use speakers accordingly to the power and impedance of the amplifier. Verify if the adjustment filters can be used to increase the performance of the equipment.



Warning!

Never use speakers with impedance under the nominal impedance of the amplifier or you may damage it.

- ▶ To avoid unwanted noise in the system, join the ground points of the equipment and audio output to only one point.
- ▶ After the end of the electrical installation, connect the negative cable of the battery and, before starting the audio system, check if all connections are correctly done.
- ▶ To adjust the gain control, use the headunit volume at 70%, playing music. Increase slowly the gain of channels 1-2 until you can notice the distortion. Reduce the gain slightly until you have a clean signal. Repeat this procedure for channels 3-4.
- ▶ Some headunits with high voltage output on the RCA, may cause the amplifier to reach maximum output even with gain control near minimum position. In this case, limit the volume of the headunit before the point where you can hear distortion.



Warning!

Gain positioning over the correct spot may cause noise, protection or damage to the speakers.

- ▶ Adjust the high pass and low pass filters according to your speaker specifications. In case of doubt, please refer to your speaker manual.

ATTENTION: Before proceeding with the installation of your SoundDigital amplifier, unplug the negative (-) terminal of the battery.

The versatility of the SoundDigital multi-channel amplifiers, allows the installation in 1 or 2 channel mode.

Below is the schematic for the 2-channel mode:

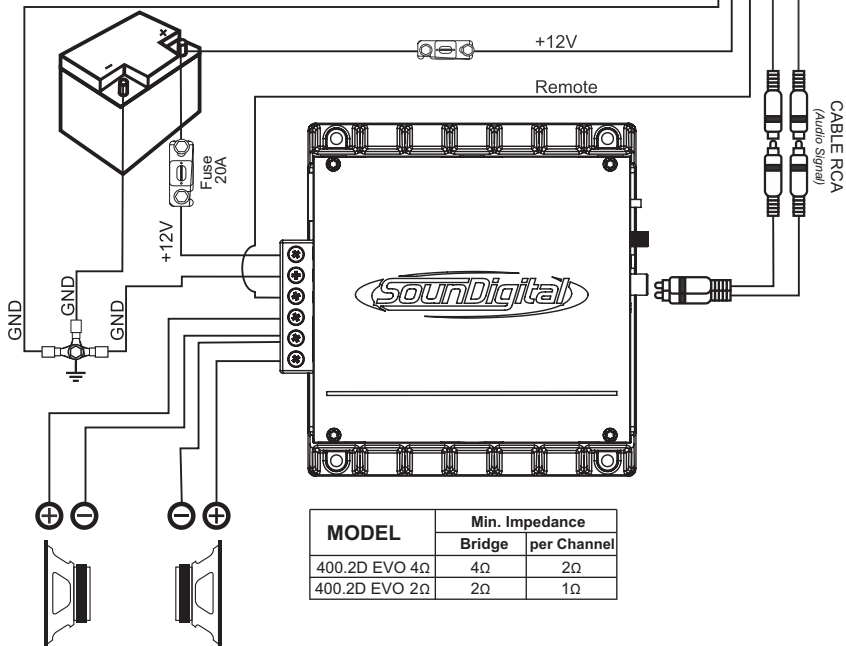
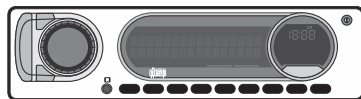

ATTENTION: Before proceeding with the installation of your SounDigital amplifier, unplug the negative (-) terminal of the battery.

The versatility of the SounDigital multi-channel amplifiers, allows the installation in 1 or 2 channel mode.

Below is the schematic for the 2-channel mode:

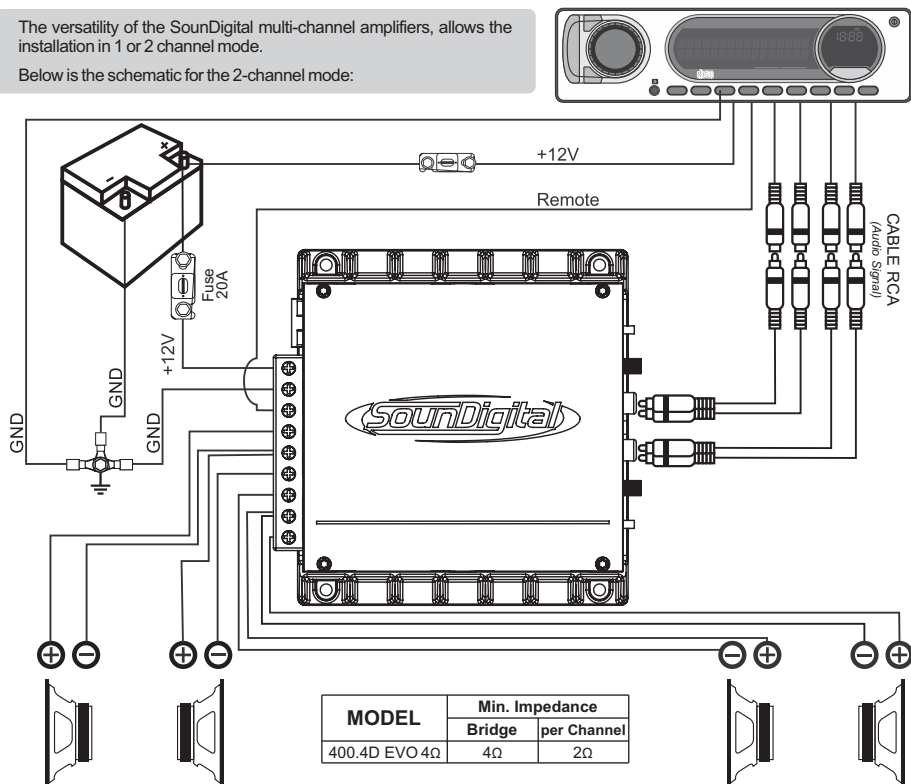

ATTENTION: Before proceeding with the installation of your SoundDigital amplifier, unplug the negative (-) terminal of the battery.

The versatility of the SoundDigital multi-channel amplifiers, allows the installation in 4, 3 or 2 channel mode.

Below is the schematic for the 3-channel mode:

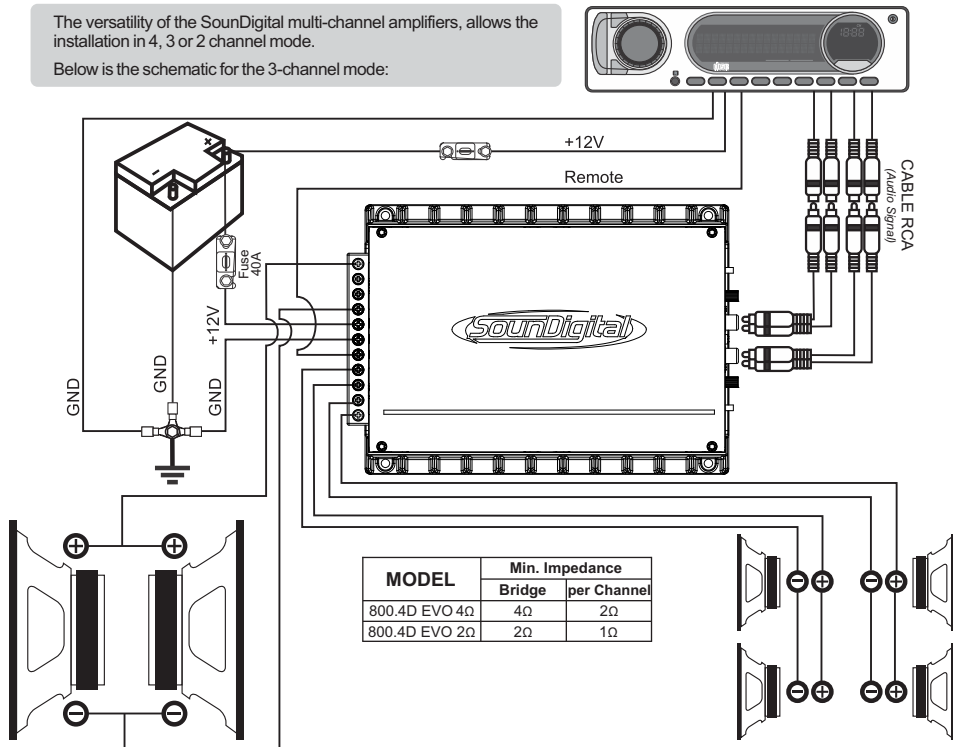

RMS Power	Channels	400.2D2 EVO 2Ω			400.4D4 EVO 2Ω		
Impedance		1Ω	2Ω	4Ω	2Ω	4Ω	8Ω
Power @ 12.6V	2X	200W	110W	61W	200W	110W	61W
Bridge Power @ 12.6V	1X	N/A	400W	220W	N/A	400W	220W
Power @ 14.4V	2X	261W	144W	79W	261W	144W	79W
Bridge Power @ 14.4V	1X	N/A	522W	287W	N/A	522W	287W

Audio Specs

SNR	99 dB
THD + N (Nominal Power)	0.22%
THD + N (50% Rated Power)	0.022%
THD + N (10% Rated Power)	0.031%
Frequency Response (- 3dB)	5Hz ~ 20kHz
Damping Factor	<200

Power supply

Operating voltage	9V to 16V
Max current draw	39A
Current draw (music)	19A
Recommend capacity of the battery	39Ah
Minimum capacity of the battery	19Ah
Fuse/circuit breaker size	20A
Size of recommended cable	8mm ² /8AWG
Total efficiency (source+output)	81.6%

Dimensions

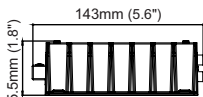
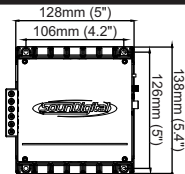

Weight: 0.67kg (1.47lbs.)

Input signal and filters

Input sensitivity	0.5V to 6V
High pass filter	80Hz
Low pass filter	80Hz

Graphics

Frequency Response

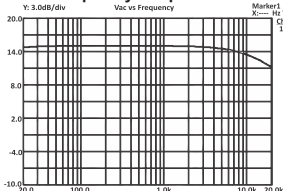

THD + N x Frequency

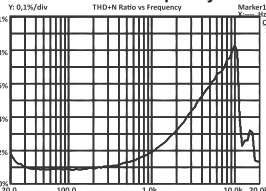

THD + N x Power

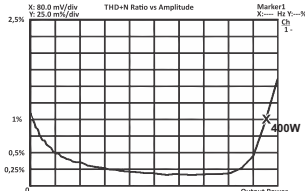

RMS Power	Channels	400.4D EVO 4Ω		
		2Ω	4Ω	8Ω
Power @ 12.6V	4X	100W	55W	30W
Bridge Power @ 12.6V	2X	N/A	200W	110W
Power @ 14.4V	4X	131W	72W	40W
Bridge Power @ 14.4V	2X	N/A	261W	144W

Audio Specs	
SNR	88dB
THD + N (Nominal Power)	0.08%
THD + N (50% Rated Power)	0.006%
THD + N (10% Rated Power)	0.009%
Frequency Response (-3 dB)	5Hz ~ 20kHz
Damping Factor	<200

Power supply	
Operating voltage	9V to 16V
Max current draw	40A
Current draw (music)	20A
Recommend capacity of the battery	40Ah
Minimum capacity of the battery	20Ah
Fuse/circuit breaker size	20A
Size of recommended cable	8mm ² /8AWG
Total efficiency (source+output)	79%

Dimensions	
Weight: 0.7kg (1.5lbs.)	

Input signal and filters	
Input sensitivity	0.5V to 6V
High pass filter	80Hz
Low pass filter	80Hz

Graphics

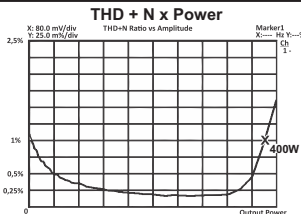
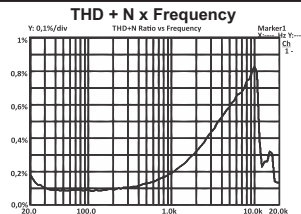
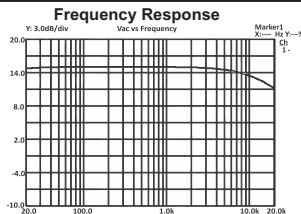

RMS Power	Channels	800.4D EVO 2Ω			800.4D EVO 4Ω		
Impedance		1Ω	2Ω	4Ω	2Ω	4Ω	8Ω
Power @ 12.6V	4X	200W	110W	61W	200W	110W	61W
Bridge Power @ 12.6V	2X	N/A	400W	220W	N/A	400W	220W
Power @ 14.4V	4X	261W	144W	79W	261W	144W	79W
Bridge Power @ 14.4V	2X	N/A	522W	287W	N/A	522W	287W

Audio Specs

SNR	99dB
THD + N (Nominal Power)	0.22%
THD + N (50% Rated Power)	0.022%
THD + N (10% Rated Power)	0.031%
Frequency Response (-3 dB)	5Hz ~ 20kHz
Damping Factor	<200

Power supply

Operating voltage	9V to 16V
Max current draw	78A
Current draw (music)	39A
Recommend capacity of the battery	78Ah
Minimum capacity of the battery	39Ah
Fuse/circuit breaker size	40A
Size of recommended cable	10mm ² /7AWG
Total efficiency (source+output)	81.6%

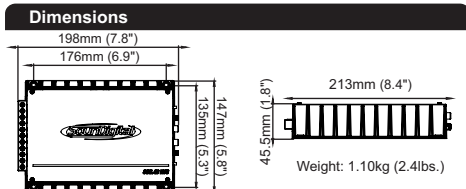

Input signal and filters

Input sensitivity	0.5V to 6V
High pass filter	80Hz
Low pass filter	80Hz

Graphics

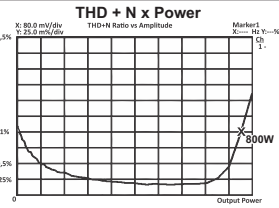
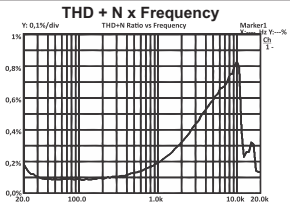
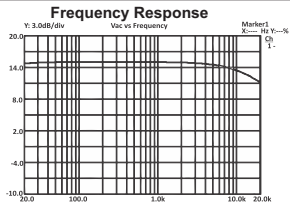

LIMITED WARRANTY

SounDigital warrants the original purchaser that this product shall be free of defects in materials and workmanship for a period of twelve (12) months from the original date of purchase. Some countries have extended warranty in case the product is installed by an authorized dealer. This warranty is not transferrable and applies only to the original customer from an authorized SounDigital dealer.

Warranty is void when:

- Defect or problem caused by misuse of the product;
- Incorrect installation or non-conformity with the Manual;
- Maintenance made by unauthorized personnel;
- Alteration or removal of the seal/serial number;
- Exposure to adverse conditions (weather, humidity, etc);
- Damage caused by fall, impact or natural depreciation, caused by transport and/or handling, risks, or smashings;
- Products was purchased more than 12 months ago.

Warranty covers:

- Component or material with manufacturing defects;
- Workmanship/service needed to repair the equipment;
- If you need service on your SounDigital amplifier, send it (freight-prepaid) to SounDigital's Amplifier Repair Center through an authorized SounDigital dealer (must be accompanied by proof of purchase);
- Any extra information you can get by contacting us at the e-mail address: info@soundigitalusa.com;
- In case of manufacturing defect or bad quality of raw material the max compensation will be the replacement of the product, not allowing any kind of compensation payment;
- New modifications/iterations on a product don't obligate the manufacturer to modify products formerly produced.





www.soundigital.com.br



+ 55 51 3042-9001



/SoundigitalBrasil



@soundigital