



**HIGH PERFORMANCE
STAINLESS STEEL EXHAUSTS**





SCHEMA DI MONTAGGIO - ASSEMBLY SCHEDULE

COD. **58.0038.00 / 58.0201.00 / 58.0222.00**

REV. **00** DEL. **04/11/2003** TEC-LOG **G.D.**

Descrizione **FIAT PUNTO II (typ 188)**

Fig. 1

-  Fissare la staffa(A) sotto la scocca della vettura ed agganciare lo scarico utilizzando il gommino(B);
-  Fix the bracket(A) under the platform of the car and hook the exhaust by using the gum-ring(B);
-  Fixer l'étrier(A) sous le montant de la voiture et en utilisant le petit bouchon en caoutchouc(B) accrocher l'échappement;
-  Fijar el estribo(A) bajo el cuerpo del coche y enganchar el escape utilizando el anillo de goma(B);
-  Fixieren Sie die Schelle(A) unter dem Karosseriekörper und setzen Sie die Anlage mit Hilfe des Gummirings(B) ein;

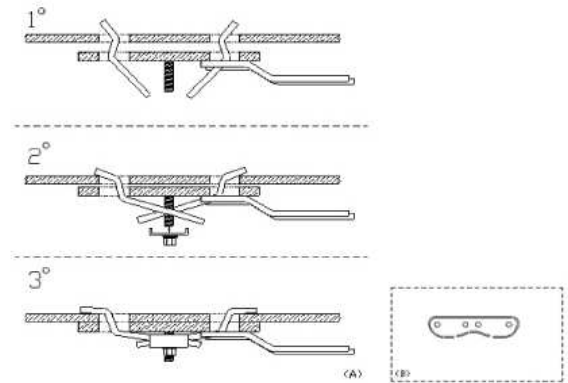







Fig. 2



Fig. 3

-  I terminali di scarico passano sotto il paraurti originale della vettura!
-  The tailpipe pass under the original rear bumper!
-  Les terminaux sortent sous le pare-chocs original!
-  Las salidas del escape pasan bajo el paragolpes original del coche!
-  Die Endrohre treten unter der originalen Stoßstange hervor!

