



20. Mount
- air vents
- hazard light switch
to fascia plate

Push fascia plate on dash board until it snaps in



21. Fix fascia plate with 2 OEM screws
(see arrows)



22. Re-install everything in reverse order to finish installation

All installation work must be performed by a qualified professional installer only.
The manufacturer / dealer is not liable for any kind of incidental or indirect damages.
© 12/2010 ALL RIGHTS RESERVED. Technical changes possible. No liability for misprints.

• Ford C-MAX 2010->

Compatible with these double DIN devices

Pioneer Navigation

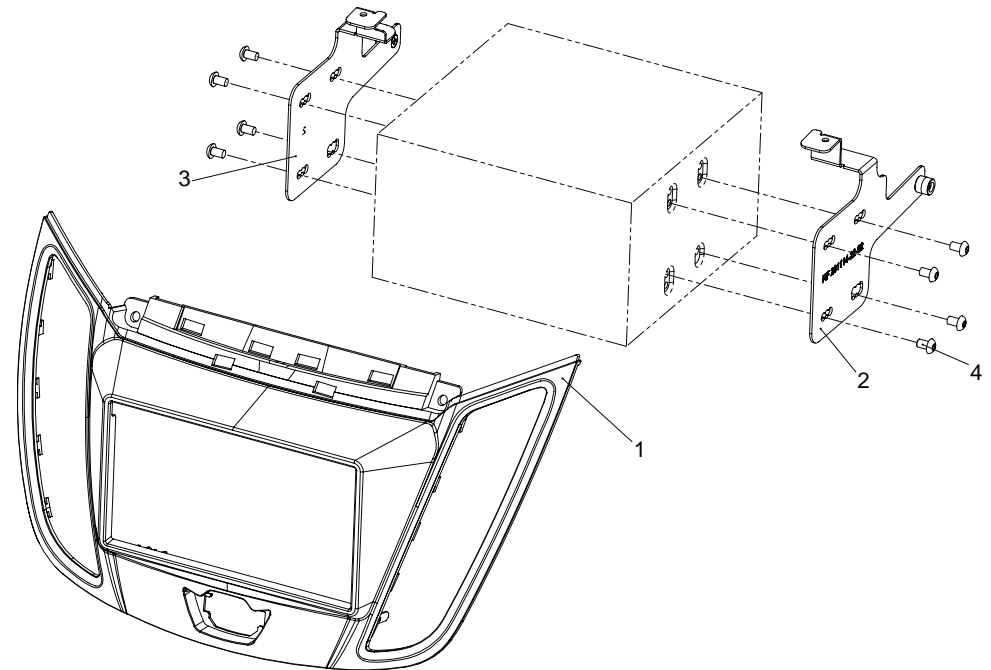

Double DIN Kit contents

- (1) Facia Plate
- (2) Mounting Bracket right
- (3) Mounting Bracket left
- (4) flat headed screws

Installation Manual Double DIN Kit



1. Ford C-MAX with OEM radio

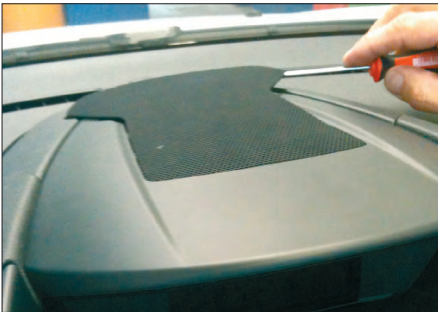

2. Unclip speaker grill at top of dash board carefully



3. Remove speaker grill



4. Unclip cover of center console



17. Dashboard after plastic cut out

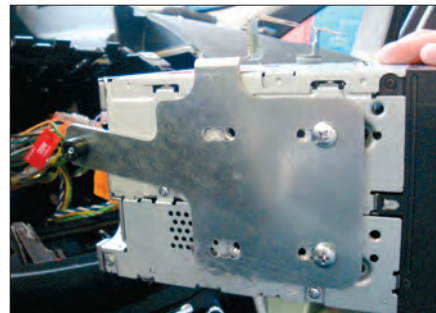

18. Fix mounting brackets to Double DIN head unit

Connect all required circuit points

Push Double DIN head unit into dash board

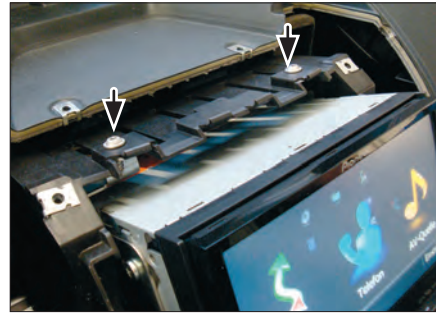

19. Fix Double DIN head unit

Installation Manual Double DIN Kit

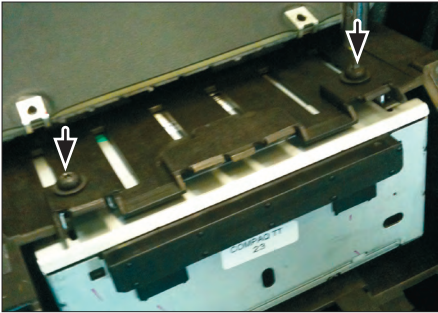

14. Remove screws of OEM Radio/CD unit
- Remove OEM Radio/CD unit



15. Cut away plastic to clear space for Double DIN head unit

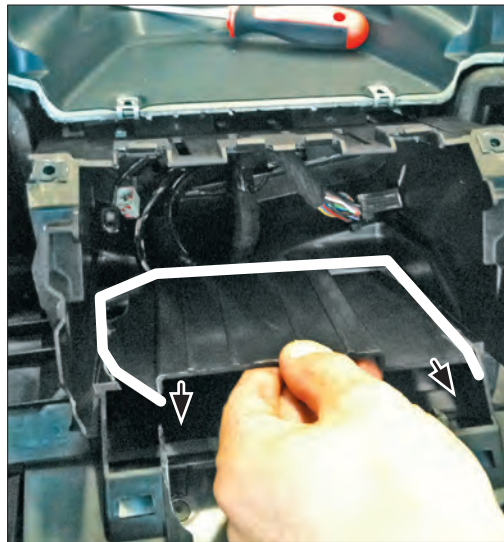

16. Remove plastic

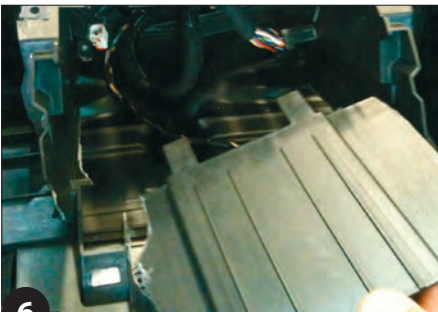

6



5. Remove screws of center console



6. Unclip cover center console



7. Remove top panel cover

3

Installation Manual Double DIN Kit

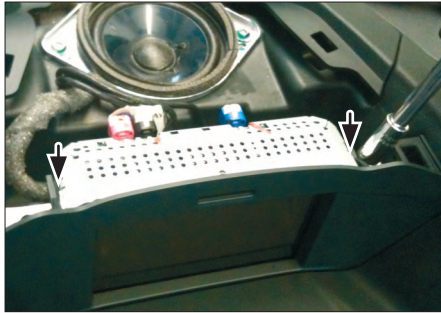

8. Unclip display

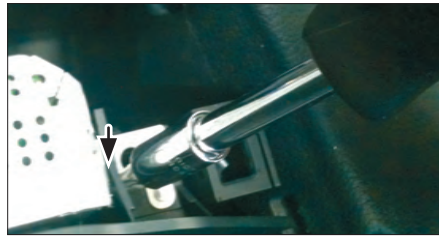

9. Remove display



10. Unclip center panel

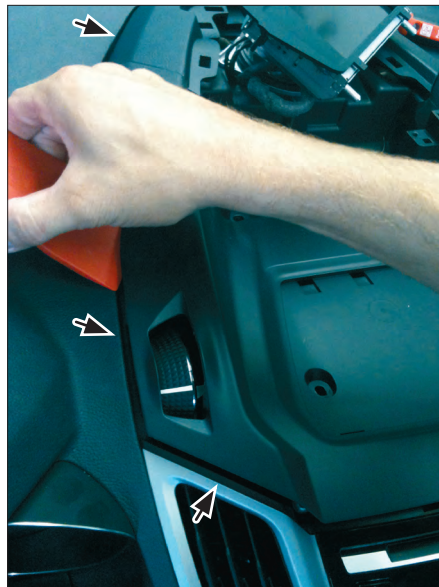

11. Remove screw (see arrow)

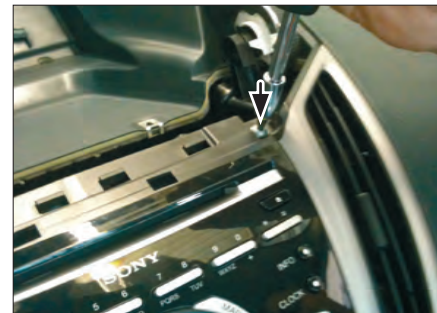

12. Remove screws on top of OEM head unit (left and right)



13. Unclip air vents
Remove air vents