

Pioneer

CA-R-VAG.001 VWGOLF 7 2013> MANUALE UTENTE



ABOUT

The Connects2 Infodapter for VW MIB platform vehicles allows vehicle information such as climate control, parking sensors and heated seats to be displayed on any aftermarket head unit with rear camera input. The Infodapter also allows the use of the steering wheel controls with almost every steering wheel control compatible head unit on the market.

DIP SWITCH SETTINGS

See Fig 1.

Up = Off, Down = On

1: On = Pioneer head units. Off = All other head units

2: Setting for reverse camera. On = PAL, Off = NTSC. The default setting is Off (NTSC).

3: Resets the display settings back to default. If the display settings have been manipulated in a way that it is no longer possible to make adjustments, change the DIP switch #3 from Off to On and back. This will reset the screen settings to the factory defaults. During this procedure the screen background will change to red. While the background is red, no settings can be made.

4: Not applicable. (This should be kept in the Up/Off position)

Interface Connections

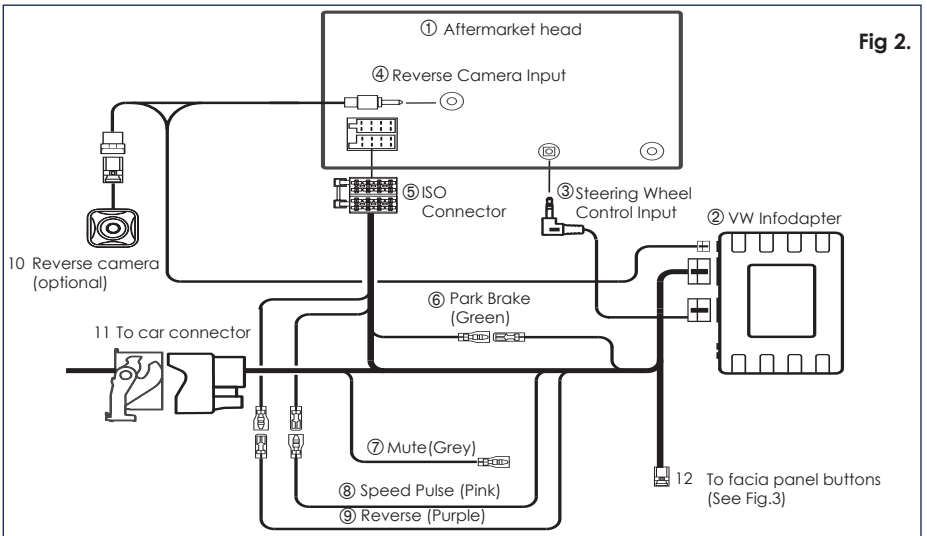
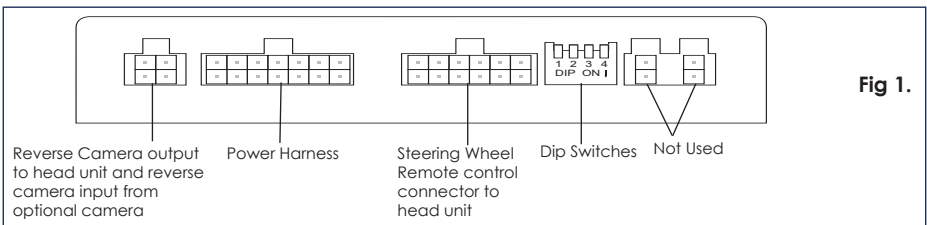

Facia/Steering Wheel Controls

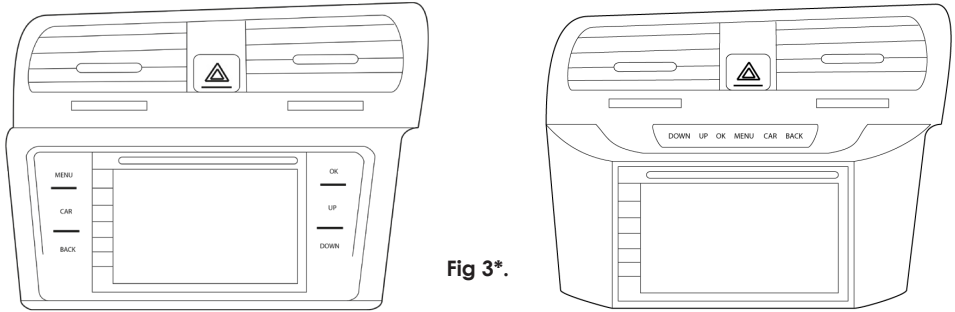
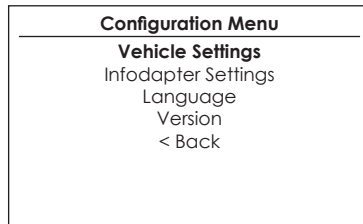

Fig 3*.

* Shown here are both available fascia types

Configuration Menu

To access the menu, **push the 'MENU' button on the fascia panel (Fig.3)** and use the **UP and DOWN buttons to navigate**. Use the **OK** button to select and **Back to go back or exit**. The **Car** button will allow access to the vehicle trip computer.



- **Vehicle Settings**
Vehicle settings can be adjusted via the menu. All vehicle setup options that were available with the original head unit, are now available through the aftermarket head unit. See the vehicle handbook for more information regarding these features.

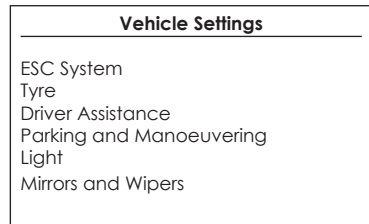

- **Infodapter Settings**
 - **Screen Size/Position -**
Make sure all 4 corner markers are touching the corners of the aftermarket head unit display. Note that you may need to adjust the screen size/position to avoid any warning messages displayed on the aftermarket head unit.

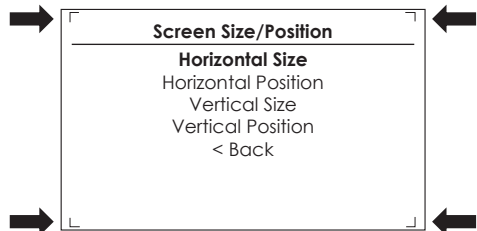

Configuration Menu...continued

- o Picture Settings - Adjust Brightness, contrast and colour saturation.

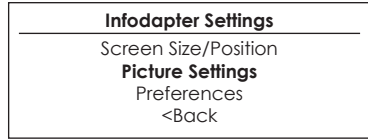

- o Preferences -

Driver Position - Select Left or Right depending upon vehicle configuration.

Camera Connected - Select Yes if an optional camera is connected.

Reverse Priority* - Select which image (Camera or Park Assist) will be shown by default when reversing. The driver can select the desired image by pushing the Source button (Fig.3) while reversing. (*Note this option is only available when Camera Connected is set to Yes)

Park Brake Source - Set to Speed, Brake or Always On.

Climate - Select how long the climate display should be shown on the head unit when adjusted. Select between the range of 3 seconds and 30 seconds.

Restore factory settings - Reverts all Infodapter settings to factory defaults. (This does not restore vehicle settings)

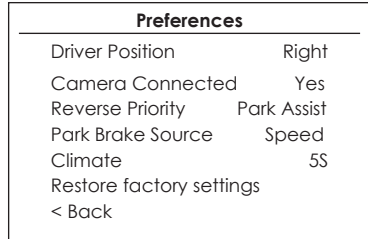

- o Driving Mode - The driving mode button can be used as normal. The graphic for the mode will be shown on the head unit.



- o Park Assist - The park assist button can be used as normal to activate/deactivate park assist. The graphic will be shown on the head unit.

Legal Information

Please consult the relevant road traffic laws governing the country in which this product is being operated. No liability is accepted for material damage, loss or personal injury, directly or indirectly, from installation and operation of this product. This product should only be operated when safe to do so.