



## Installation Manual INE-W928R Kit

colour: black

- Seat Alhambra (6N)
- Škoda Fabia II
- Škoda Octavia II
- Škoda Roomster
- VW Caddy
- VW Sharan
- VW Tiguan
- VW Touran

part-no.:  
KIT-8VWT  
KIT-8VWTD

Compatible with these Alpine navigation devices

### INE-W928R

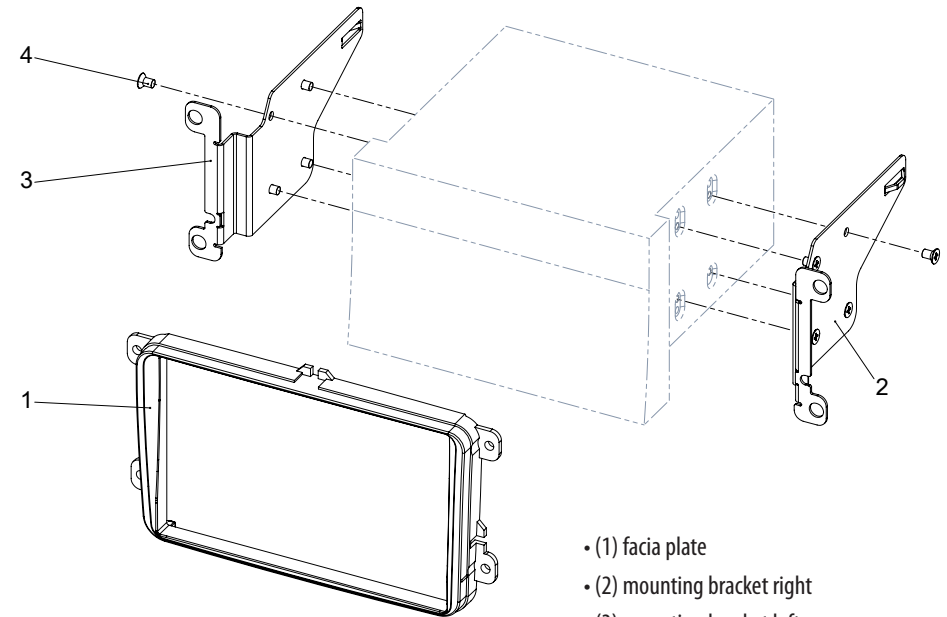

- (1) facia plate
- (2) mounting bracket right
- (3) mounting bracket left
- (4) recessed countersunk flat head screw

*All installation work must be performed by a qualified professional installer only.  
The manufacturer / dealer is not liable for any kind of incidental or indirect damages.*

## Škoda Fabia II / Octavia II / Roomster / VW Caddy / Touran



1. Unclip and remove OEM panel  
(see arrows)



2. Remove 4 screws  
  
Remove head unit

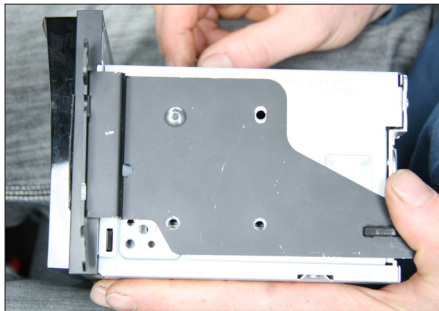

3. Attach mounting frames to  
Alpine INE-W928R



4. Connect all required circuit points  
  
Place Alpine INE-W928R  
on dashboard

## VW Tiguan

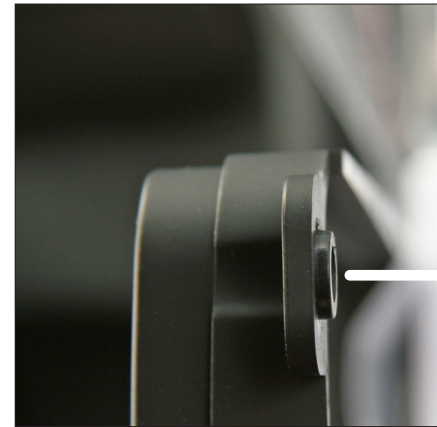

5. Connect all required  
circuit points  
Place Alpine INE-W928R  
on dashboard

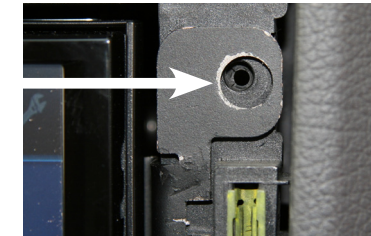

Place fascia plate  
*Put dome of fascia plate  
exactly over the holes of  
mounting frames  
(see arrow above)*



Install OEM panel to finish  
installation

## VW Tiguan



1. Unclip and remove OEM panel (see arrows)

Remove 4 screws of OEM head unit



2. Remove 4 screws

Remove head unit

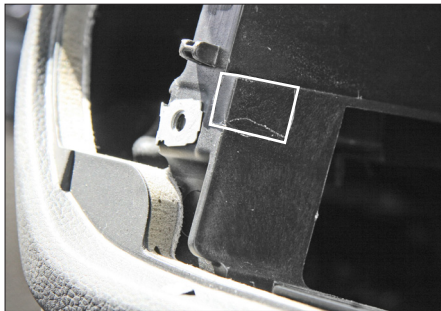

3. Cut away plastic to clear space for Alpine INE-W928R

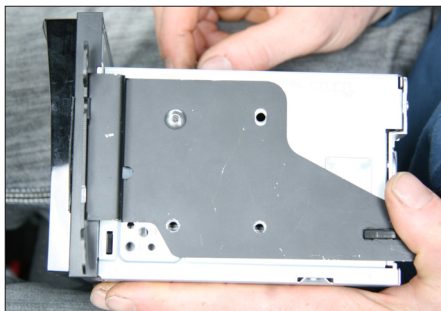

4. Attach mounting frames to Alpine INE-W928R

## Škoda Fabia II / Octavia II / Roomster / VW Caddy / Touran

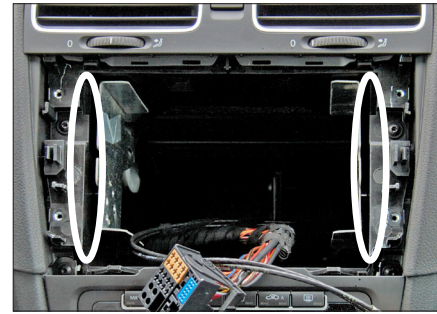

5. **If necessary:**  
Cut away plastic to clear space for Alpine INE-W928R

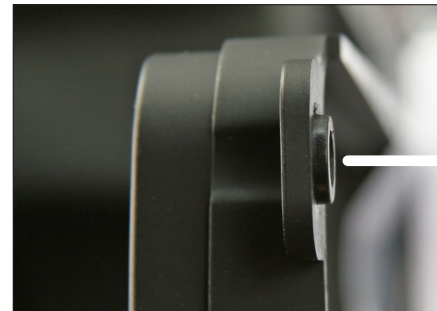

6. Place facia plate

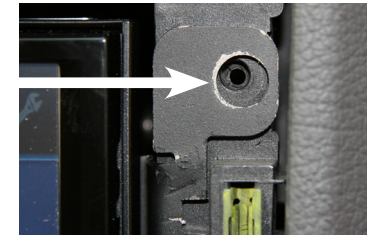

*Put dome of facia plate exactly over the holes of mounting frames (see arrow above)*

Fix facia plate with 4 screws



7. Install OEM panel to finish installation





## Seat Alhambra / VW Sharan



1. Open top shelf  
Remove 2 screws



2. Remove top shelf inlay  
Remove 2 screws on top



3. Remove OEM panel

## Seat Alhambra / VW Sharan



4. Remove 4 screws  
Remove OEM head unit  
  
**If necessary:**  
Cut away plastic to clear space  
for Alpine INE-W928R

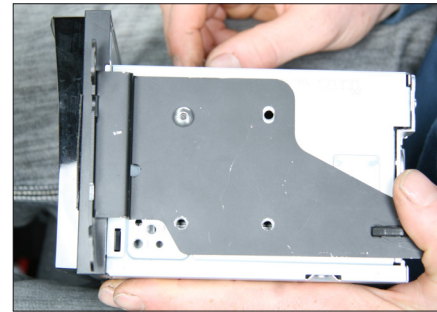

5. Attach mounting frames to  
Alpine INE-W928R

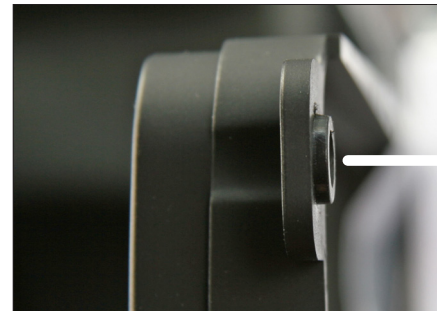

6. Place fascia plate

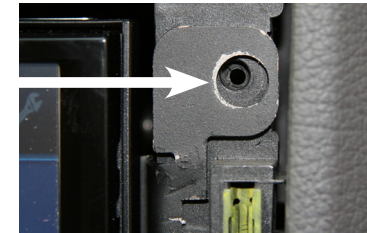

7. Connect all required circuit  
points  
Place Alpine INE-W928R  
on dashboard

Fix fascia plate with 4 screws  
Install everything in reverse  
order to finish installation