

Mounting the subwoofer

1. Find a suitable location in the vehicle in which to mount the amplifier.
A typical location is shown below:

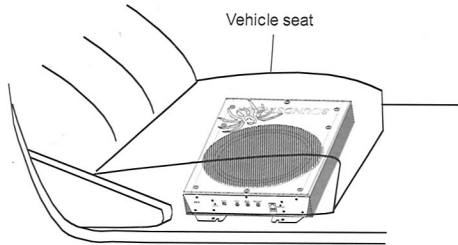

2. Make sure there is sufficient air circulation around the intended mounting location.
3. Mark the location for mounting hole screws by positioning the cabinet where you wish to install it. Make a small mark to identify the position and remove the unit. Thoroughly clean the area you plan to attach the subwoofer, using a vacuum cleaner. Then attach the supplied double adhesive tape, and put the subwoofer in the place and press down on it securely.

Troubleshooting

If you experience operation or performance problems with this product, compare your installation with the electrical wiring diagram on the previous pages. If problems persist, read the following troubleshooting tips which may help eliminate the problems.

PROBLEM	POSSIBLE REASON	SOLUTION
Not switching on. Power LED not 'on'	• NO+12v to power wire	• Check fuses and connections to battery
	• No power to remote wire	• Check remote on connections to head unit
	• Fuse broken	• Replace fuse with correct type and amperage
Not working, but status LED 'on'	• Fuse blown	• Replace fuse with correct type and amperage
	• Amplifier too hot	• Move unit to vented area • Turn head unit down
No sound	• Head Unit	• Check head unit volume level
	• Gain control not set up	• Ensure you have set up the amplifier gain level control
	• Connections	• Check all power, remote on and ground connections

SOUNDSTREAM

SOUNDSTREAM

USB.8A

150W RMS PRELOADED UNDER SEAT ENCLOSURE W/8" SUBWOOFER & AMPLIFIER



OWNER'S MANUAL

Congratulations on your purchase of a **SOUNDSTREAM USB.8A**
Slim Amplified Subwoofer.

It has been designed, engineered and manufactured to bring you the highest level of performance and quality, and will afford you years of listening pleasure.

Thank you for making a **SOUNDSTREAM** your choice for car audio entertainment!

USB.8A

150W RMS PRELOADED UNDER SEAT ENCLOSURE W/8" SUBWOOFER & AMPLIFIER

- 8" Slim woofer
- RCA low level input
- High level input
- Green & red LED power status indicator
- Remote level control
- Phase shift switch: 0 or 180°
- Adjustable input sensitivity: 0.2V-3V
- 0 to+12dB variable Bass Boost (@45Hz)
- Low pass filter (50-150 Hz)
- Soft delay remote turn-on
- Thermal, short and overload protection circuits
- Fuse: 2x15A
- RMS Power: 150Watt
- RMS Power: Amplifier 85Watt
Slim woofer 200Watt
- Dimension: 14.5" X9.5" X 3"
- Weight: 10.5 LBS.

Introduction

With the USB.8A , we are introducing a low-profile amplified subwoofer. Low enough to easily fit below the seat of your car, This system offers you a quick and easy way to add a high-powered subwoofer system to your audio system.

The integrated amplifier in the USB.8A features both high pass and low pass crossovers, and a control for adjusting the input sensitivity from 0.2V to 3V.

Both high level (speaker level) and low level (RCA type) inputs are present, making this a universal solution for use with any head unit or other input source.

For further flexibility in the use of a subwoofer, a variable bass boost control has been included. You can control the subwoofer level with the remote level control module.

What is included?

When first unpacking your new amplified subwoofer, please check first that the package contains all of the items below. If something is missing, contact the store where you purchased the product.

- **USB.8A amplified subwoofer**
- **Remote subwoofer level control**
- **Remote subwoofer control cable**
- **High level input wire**
- **Mounting hardware**

Front panel controls and features

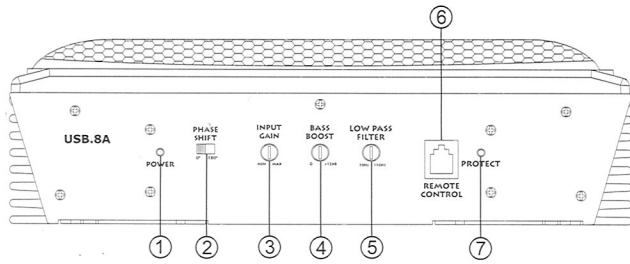

① POWER ON LED INDICATOR

② PHASE SHIFT

Use this switch to help compensate for time alignment problems in the system. Such problems usually result from having the subwoofer at a different distance from the listener than the other speakers in the system.

③ INPUT GAIN CONTROL

After you have installed your system, turn this control to minimum. Turn the head unit on (and the subwoofer will turn on via the remote connection). Turn the head unit volume to about 2/3 full level. Slowly turn up the subwoofer input gain control until you hear a small amount of distortion. Then reduce the level until the distortion is completely gone. Leave the control at this setting.

④ BASS BOOST

The bass boost feature will increase the sound level the bass frequencies.

⑤ LOW PASS FILTER

This control permits you define the frequency range you want the subwoofer amplifier to receive. The subwoofer will reproduce all sound BELOW the frequency you set.

If the rest of your system is weak on the mids, you may wish to set this control relatively high. If the midrange is well covered by the rest of your system, you will probably want the subwoofer to only receive lower frequency signal.

⑥ REMOTE LEVEL CONTROL PORT

Attach the included remote level control to control the volume level of the subwoofer independently.

⑦ PROTECT LED INDICATOR

Rear panel controls and features

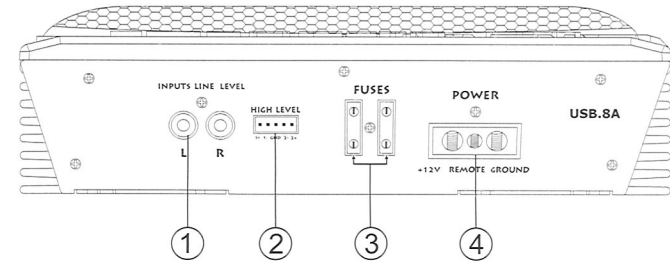

① LOW LEVEL RCA INPUTS

Low level inputs are the recommended way to introduce the audio signal to the subwoofer if RCA outputs are present on your head unit or other signal source (such as a sound processor).

② HIGH LEVEL (speaker level) INPUTS

If your head unit does not have RCA outputs, you can use the speaker outputs for the audio source for the USB.8A. Use the supplied cable and connect the outputs properly as shown in the connection diagram in this manual.

③ FUSE

The fuse is rated at 15A. Do not use a fuse with a different value and NEVER replace the fuse with a wire or coin.

④ POWER TERMINALS

Low Level Input Wiring

Low-level (RCA) input wiring is preferred for best audio performance. Most trunk or hatchback installations will require a 15-20 foot RCA cable, while pickup trucks and under-seat installations will require a 6-12 foot RCA cable. Always use a high-quality cable.

NOTE: Do not connect BOTH the high level and low level inputs from your receiver to your amplifier at the same time!

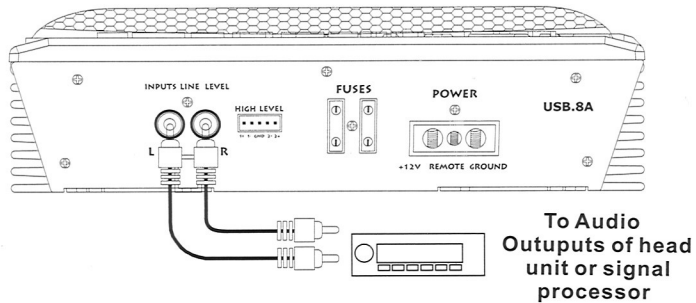

High Level Input Wiring

The high level input(s) should only be used when your receiver lacks RCA outputs. If the RCA outputs are not present, connect the speaker outputs from the receiver to the high level input connector of the amplifier. Be sure to observe polarity to avoid audio phase problems.

NOTE: Do not connect BOTH the high level and low level inputs from your receiver to your amplifier at the same time!

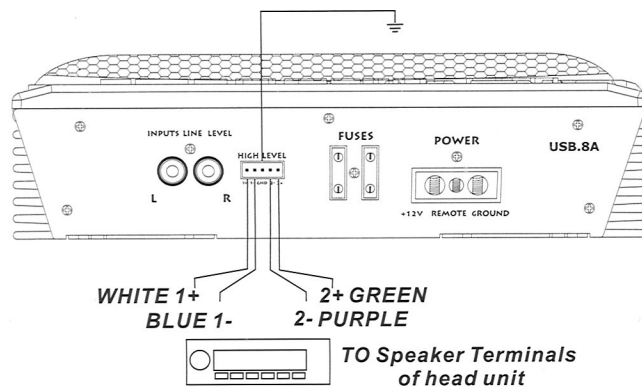

Power Connections

Connect the ground terminal to the closest point on the chassis of the vehicle. Keep this ground wire to less than 39" (100 cm) in length. Use 8 gauge (or heavier) wire.

Connect the remote terminal to the remote output of the head unit using 16 gauge (or heavier) wire.

Connect an empty fuse holder within 18" (45 cm) of the car battery, and run 8 gauge (or heavier) cable from this fuse to the amplifier location. Then connect the fuse holder to the "BATT+" connection on the subwoofer rear panel

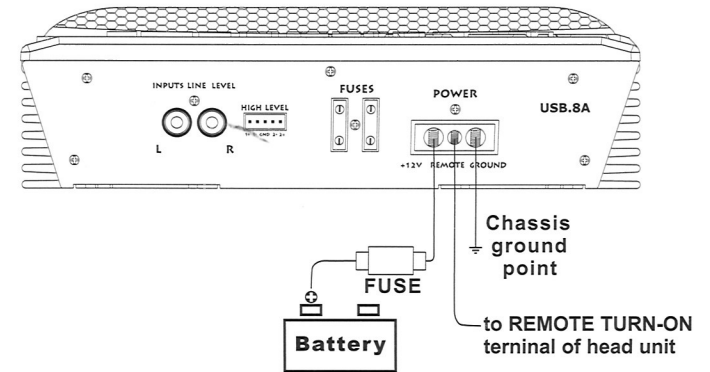

Remote Level Control Connection

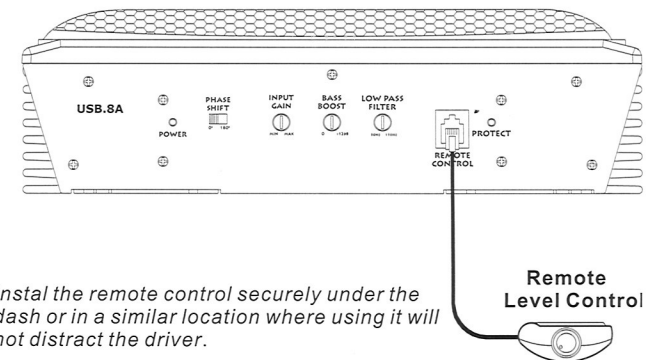

Install the remote control securely under the dash or in a similar location where using it will not distract the driver.