

RS 100

Midrange specifications:

Name		HG-100RS-3
DC resistance	R _{dc}	2,5 Ω
Nominal impedance	Z _N	3 Ω
Resonance frequency	f _s	114,6 HZ
Voice coil diameter		25 mm
Mechanical Q factor	Q _{ms}	3,74
Electrical Q factor	Q _{es}	1,1
Total Q factor	Q _{ts}	0,85
Moving mass	M _{ms}	6,86 g
Effective piston area	S _d	56 cm²
Mechanical resistance	R _{ms}	1,44 Kg/s
Compliance	C _{ms}	0,28 mm/N
Force factor	BL	3,26 Tm
Equivalent air volume	V _{as}	1,23 dm³
Efficiency	η	0,16 %
SPL 2,83V/1m		89,0 dB

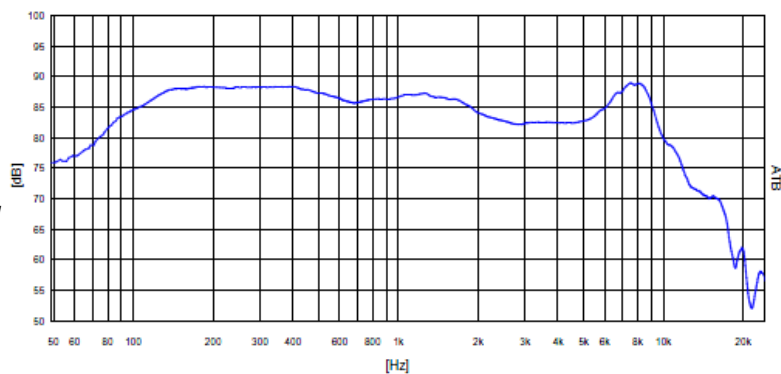

Cone: **Fiberglass**
 Spider: **Nomex**
 Surround: **Rubber**
 Coil former: **Aluminum**
 Basket: **Steel**
 Dust cap: **Fiberglass**

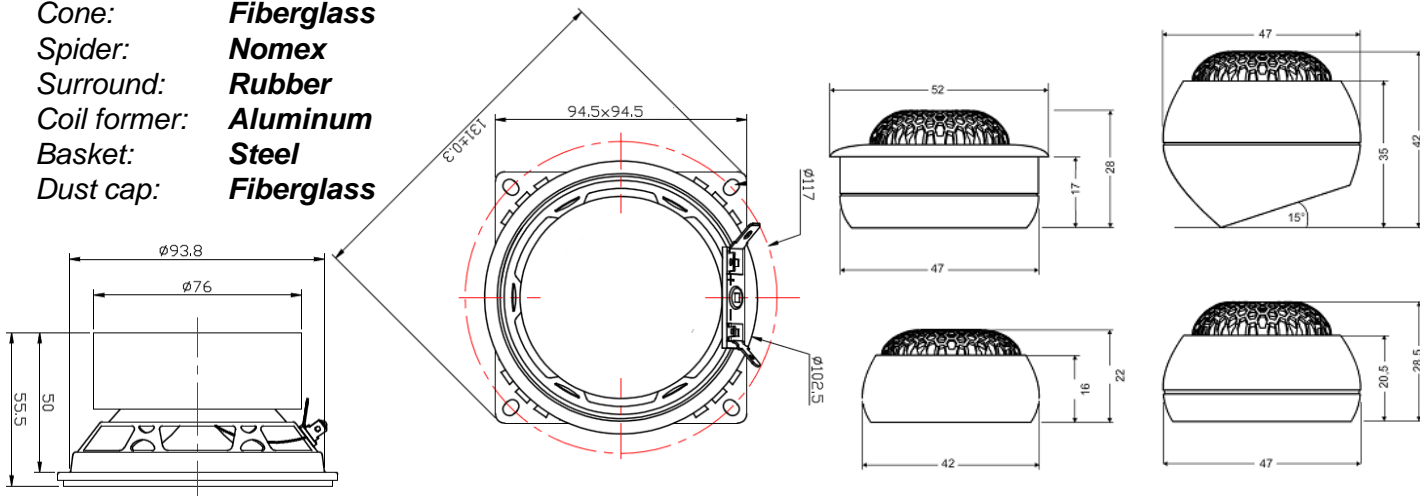

Tweeter specifications:

Name		HG-25GF
DC resistance	R _{dc}	3,4 Ω
Nominal impedance	Z _N	4 Ω
Resonance frequency	f _s	1535 HZ
Voice coil diameter		25 mm

