

ZGL060010



Constant Current Discharge Rating Amperes @ 25°C (77°F)

F.V/Time	5M	10M	15M	30M	1HR	2HR	3HR	4HR	5HR	8HR	10HR	20HR
5.25	14.6	10.3	8.19	5.04	3.04	1.59	1.14	0.93	0.76	0.51	0.43	0.23

Characteristics

Capacity 25°C (77°F)	20 hour rate 5 hour rate	4AH 3.40AH
Internal Resistance	Full charged Battery 25°C (77°F)	23mΩ
Capacity affected by Temperature (20 hour rate)	40°C (104°F) 25°C (77°F) 0°C (32°F) -10°C (14°F)	107% 100% 76% 66%
Self-Discharge	Batteries can be stored for more than 6 months at 25°C. Self-discharge ratio less than 3% per month at 25°C. Please charge batteries before using.	
Standard Terminal	F1	
Max. Discharge Current 25°C (77°F)	45A (5s)	
Final Discharge Voltage V/cell	1.75V	1.70V
Discharge Current (A)	(A) ≤ 0.2C	0.2 < (A) < 1.0C
Charging (Constant Voltage)	Cycle Initial Charging Current 1.35A Or Small 7.3V~7.4V/ 25°C (77°F) Float 6.8V~6.9V/ 25°C (77°F)	
Container Material	A.B.S. (UL94-HB), Flammability resistance of UL94-V1 can be available upon request.	

Specifications

Nominal Voltage	6V	
Rated Capacity (20 hour rate)	4Ah	
Dimension	Total Height (with terminals)	101mm (3.97inches)
	Height	101mm (3.97inches)
	Length	70mm (2.75inches)
	Width	47mm (1.85inches)
Weight	Approx. 0.72kg (1.58lbs)	

Discharge characteristics 25°C (77°F)

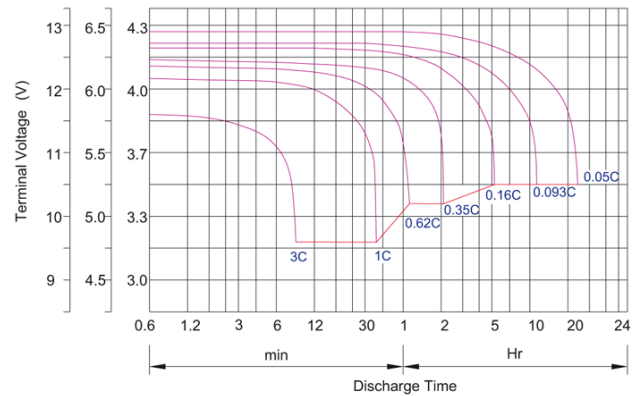

Charge characteristic Curve for standby use

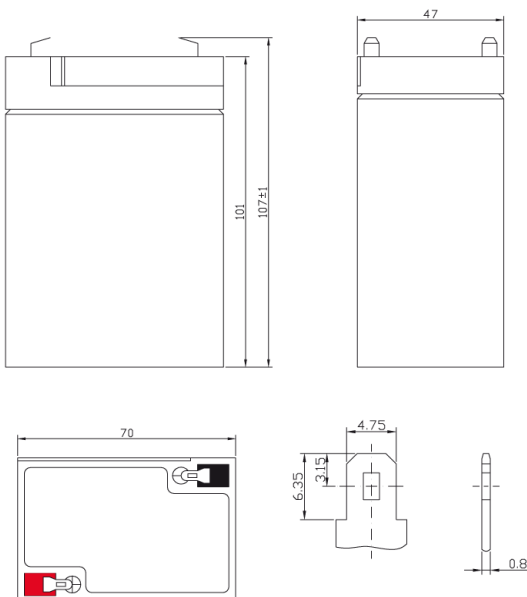
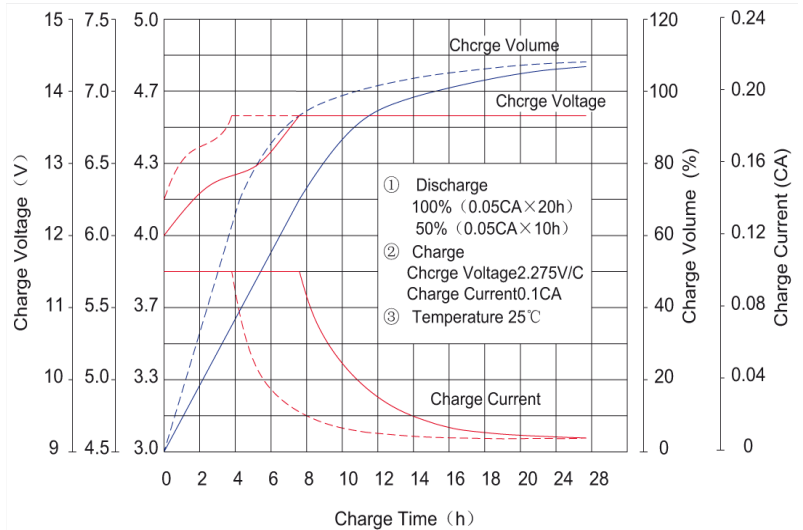

This information is generally descriptive only and is not intended to make or imply any representation, guarantee or warranty with respect to any cells and batteries. Cell and battery designs/specification are subject to modification without notice. Contact U.B.S. UNION BATTERY SERVICE for the latest information.

DIVISION OF



www.zenithdcbattery.com