

**DOUBLE DIN RADIO**

- 1 Cut and remove center divider from double DIN trim-plate. (Figure A)
- 2 Place the double DIN trim-plate on the front of the radio. (Figure B)
- 3 Place one of the ISO spacer brackets and the right factory mounting bracket (Removed from radio during disassembly) on the right side of the radio. (The spacer bracket should be between the radio and the factory bracket.) Align the pins on the trim-plate with the holes on the factory bracket and mount the factory bracket to the radio using screws supplied with the radio. (Figure B)
- 4 Place one of the ISO spacer brackets and the left factory mounting bracket (removed from radio during disassembly) on the left side of the radio. The spacer bracket should be between the radio and the factory bracket. Align the pins on the trim-plate with the holes on the factory bracket and mount the factory bracket to the radio using screws supplied with the radio. (Figure B)
- 5 Attach the radio bracket assembly to the radio trim panel using the factory screws removed during disassembly. (Figure C)

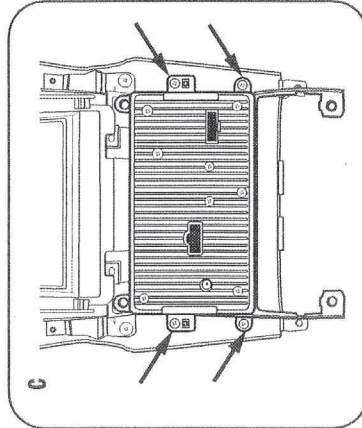

**Nissan 350Z 2003 → 2005**

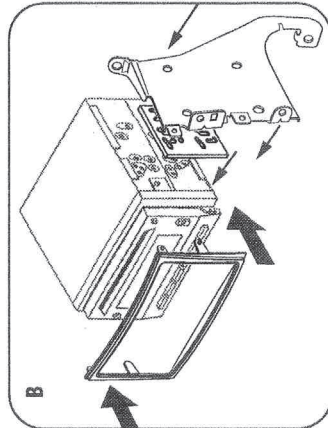
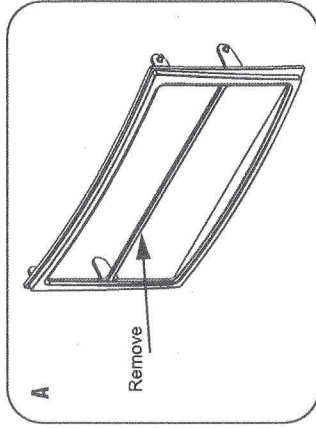
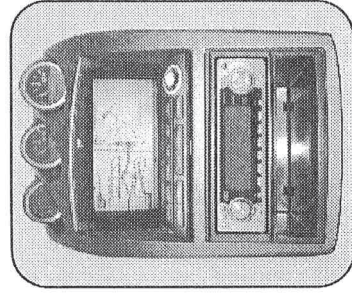

**KIT COMPONENTS**

A) Radio Housing with Pocket B) Double DIN Trim-plate C) ISO Spacer Brackets D) ISO Snap-in Brackets E) ISO Trim-plate

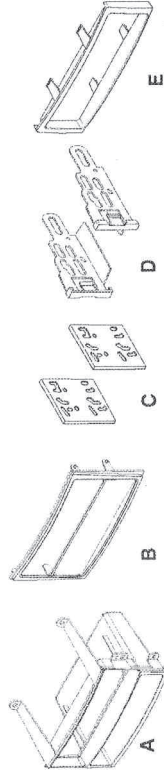

**TOOLS REQUIRED:**

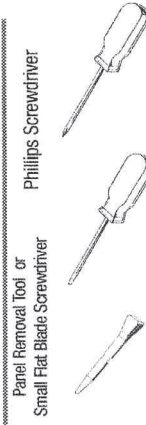

Compatible with these Pioneer devices

**Pioneer Navigation**

## NISSAN 350Z 2003-2005

- 1 Disconnect the negative battery terminal to prevent an accidental short circuit.
- 2 For vehicles with automatic transmission, Unsnap and remove smaller trim-ring from around shifter. (Figure A)
- 3 For vehicles with manual transmission, Unscrew and remove shifter knob. (Figure A)
- 3 Unsnap and remove center console trim panel including climate controls. (Figure B)
- 4 For vehicles with navigation, Unsnap and remove navigation switch panel. (Figure C)
- 5 For vehicles without navigation, remove pocket mat, then remove two screws that secure switch mask. (Figure D)

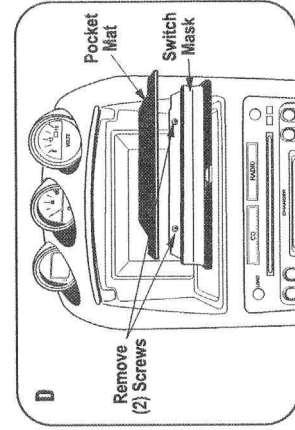
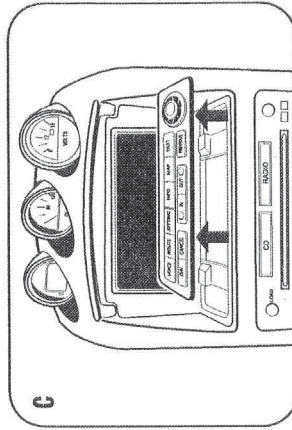
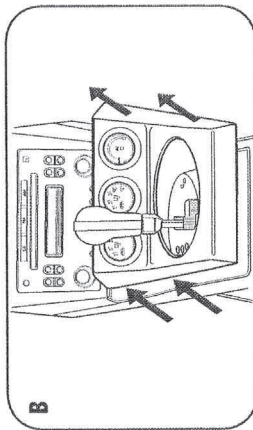
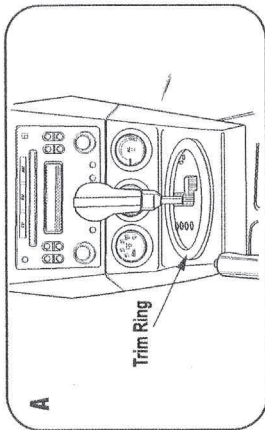

## NISSAN 350Z 2003-2005

- 6 Remove (2) screws above the radio and (2) screws below the radio. Also remove (2) screws securing the radio/trim panel assembly. (Figure E)
- 7 Unplug and remove the radio / trim panel assembly. (Figure F)
- 8 Remove (4) screws securing the radio to the trim panel and remove the radio.
- 9 Remove (8) screws securing the factory brackets to the radio and remove the brackets from the radio. (These brackets are required for stacked ISO and double DIN installations. You can skip this step for DIN or ISO installations with pocket).

